



## Experimental Investigation of Soiling and Temperature Impact on PV Power Degradation: North East-Iraq as A Case Study

Gufran Adnan Jendar<sup>1</sup>, Layth Abed Hasnawi Al-Rubayea<sup>1\*</sup>, Qusay Hassan<sup>1</sup>, Bartosz Ceran<sup>2</sup> and Abdulmajeed Mohamad<sup>3</sup>

<sup>1</sup>Department of Mechanical Engineering, University of Diyala, 32001 Diyala, Iraq

<sup>2</sup>Faculty of Electrical Engineering, Poznań University of Technology, Poznań, Poland

<sup>3</sup>Department of Mechanical and Manufacturing Engineering, University of Calgary, Calgary, Canada

### ARTICLE INFO

#### Article history:

Received June 27, 2022

Accepted August 3, 2022

#### Keywords:

Solar energy

Photovoltaic cell temperature

Soiling effect

Module power degradation

### ABSTRACT

The main objectives of this study are to assess the degradation of power, voltage and current for photovoltaic (PV) modules in predicting temperature and soiling based on five-month measurements. This study aimed to present simple experimental models for estimating the temperature and effects of dust on PV power generation. Results demonstrated that soiling short-circuit current loss underestimates the real soiling power loss by approximately 8%, and this value rises with the increase in dust density. The soiling rate during the week of dust deposition was 0.3% per day and during the final week was 0.15% per day. Results indicate that the polynomial model from the second degree is more accurate than the linear and power models for evaluating the influence of dust on PV systems in the case study. The results suggest that such analysis is required to arrive at a realistic estimation of the best cleaning time in PV power plants.

## 1. Introduction

Solar energy is starting to emerge as an optimal solution in a world that harvests the disadvantages of using fossil fuels for decades. Nowadays, solar panels can be connected to produce electricity with limitless options, given that the sun is entirely renewable with the continuous technological development of these systems [1, 2].

Due to the position of the Middle East in the heart of sunbelt regions, it has the most significant application potential [3]. Solar activities available for investment in Iraq depend on the intensity of solar radiation. Many areas have a potential for the large-scale installation of solar power plants with the opportunity to harvest solar energy for an extended period of the year [3]. This instance

contributes to solving a problem rooted for years in Iraq and enhances the individual's ability to help the society overcome the electricity crisis. If the appropriate infrastructure is available in Iraq, then the individual may supply the national grid with electricity and shift from consumption to production. In contrast, in addition to geographic locations, climatic variables (e.g., high temperature, desert or metropolitan sites) and environmental circumstances (e.g., dust deposition, sand soiling, temperature or pollution) have a significant role in the total energy production of these systems.

Dust accumulation and temperature are amongst the essential destination properties that have attracted researchers worldwide to provide better explanations and to mitigate their effects on photovoltaic (PV) effectiveness to maximise the energy yield and minimise the power losses

\* Corresponding author.

E-mail address: [laythabed2014@gmail.com](mailto:laythabed2014@gmail.com)

DOI: [10.24237/djes.2022.15402](https://doi.org/10.24237/djes.2022.15402)

caused by these factors. The impact of operational and environmental variables on the performance of PV systems with and without dust deposition is a critical issue [4].

This study aims to find appropriate solutions to use renewable energy sustainably by relying on solar panels. To increase the sources of electrical energy in Iraq by maximising the utilisation of the solar PV system, a system that measures the effect of dust and temperature on the generation efficiency of PV panels has been manufactured and tested. In this scenario, two plates were used, and the total power produced by them and their relationship to voltage and current were compared. The PV panels have been cleaned within a specific schedule and period. Hence, one of the PV panels remained clean, and the other was exposed to weather factors, such as dust and dirt. The current study characterised this effect realistically and practically in central Iraq, specifically in Diyala Governorate.

Numerous literatures reviewed the correlation of solar cell efficiency with temperature and dust. For example:

*Kim et al.* [5] investigated a PV module's thermal properties in response to temperature variations by using a thermogravimetric simulation tool. A 125 W PV panel model was also provided. When the environmental temperature was increased from 25 °C to 50 °C, the open-circuit voltage (VOC) concentration decreased, but the short-circuit current (ISC) concentration increased. The increase in the ambient temperature might drastically degrade the performance of the module. The interior temperature profile of a PV module might be approximated, with the cell and strip having perfect temperatures.

*Kaushik et al.* [6] completed a comprehensive thermal study of PV cells based on the laws of thermodynamics. According to estimations, the maximum feasible energy conversion of the PV cell is 82.8%. In this case, to enhance the efficiency of PV cells, the proper steps are taken to reduce the cell's temperature, which is mainly affected by photons from the material. Heat conduction can be retrieved from the PV cell by using a cooling fluid or channel, thereby making the PV cell and the cogeneration

cell more energy efficient. The study will assist in measuring the many sorts of irreversibility that arise in the PV energy conversion system.

*Al Hanai et al.* [7] studied the performance evaluation of a grid-connected thin-film PV system in Abu Dhabi. Due to the desert environment, dust collects very quickly within a short period, thereby reducing the overall system performance. The effect of environmental temperature on system output was considered. The Staebler–Wronski effect, which is a property of amorphous silicon and causes the system's output to drop after prolonged exposure to light and is detrimental to its performance, has also been observed.

*Lau et al.* [8] suggested that temperature fluctuations in the tropics were much greater than those in locations far from the tropics. As a result, temperatures may have a negative effect on the output of PV systems. In general, the study proved that the optimum performance of the PV array is achieved by increasing the solar radiation on its surface whilst decreasing its overall temperature.

*Gökmen et al.* [10] relied on the design and testing of a system that contributed to the correct estimation of the true potential of PV cells, especially in stormy sites, by considering the often-underestimated effects of ambient temperatures and rapidly cooling down based on the wind. They also explored the optimum tilt angle changes, and annual power comparisons were made for optimisation with and without wind speed. A more accurate mathematical model is presented to estimate annual power gain. This technique determines the optimum angles of inclination for several time periods. The experiment was conducted in Aalborg, Denmark, a windy city in northern Europe. In addition, the presented technology is simply applicable to any regions of the world.

*Kaldellis et al.* [11] was considered a critical study because it evaluated the effects of weather conditions on the performance indicators of PV systems, such as efficiencies and temperatures. This work used two non-ventilated PV systems and an open racking system in southern Greece for a year. The observed data include parameters, such as electrical output, solar radiation, wind speed, unit and environmental

temperature at the two test sites at the PV array level. The researchers concluded that the temperature range of the team is critical to the photoelectric conversion, which affects the efficiency of the electric cell negatively. Therefore, the energy performance of the PV module depends on the operating temperature, not to mention other weather conditions. The results clearly showed that the contrast between the cell and the ambient temperature decreases with the increase in wind speed.

*Amelia et al.* [12] studied the effects of temperature on the conversion efficiency of PV systems in Perlis, Malaysia using two methods: the first method used simulations, and the second one used experimental means, and both methods were compared to the combined error present for simulation methods. This work analyses the thermal dispersion analysis based on PV module temperatures. The output power of the PV modules decreases efficiency with the increase in temperature.

*Dubey et al.* [13] were interested in conducting a comprehensive review of the effect of temperature on the production of PV energy worldwide. The study concluded that many previous studies have proven that the performance of solar cells decreases with the increase in temperature due to the increment in the rates of internal carrier reconstitution that resulted from increasing carrier concentrations. They consider the geographical distribution factor for the installation of PV cells. Also, they studied the effect of solar radiation and ambient temperature on 'the performance, efficiency and production of these PV systems.

*Bryan et al.* [14] were interested in the opportunity to minimise the heating of PV cells to increase energy production in the long term. Maximising the reflection of unusable radiation for energy conversion is a promising way to reduce the operating temperature of field units. The researchers conclude an excellent opportunity to reduce the operating temperature by rejecting as much unusable light as possible.

*Mohammed* [15] studied the temperature distribution in a partially shaded PV module under the active and passive conditions of a bypass diode in the laboratory and open air by using a thermoelectric model that contained 36

cells arranged in two sub-modules. The uneven illumination between PV cells leads to temperature imbalance, which can have an immediate effect on energy and a long-term impact on reliability and efficiency. The results showed that the shading conditions under which the thermal shadow effect factor would amplify the temperature gradient when the bypass diode state changes from inactive to active led to a significant increase in the temperature of the shaded cell.

*Zaini et al.* [16] focused on identifying the effects of temperature on the performance of a monocrystalline PV panel. The study used experimental work, and the results were validated using an interview simulation using MATLAB/Simulink software. The experiment and simulation results showed that the electrical variables change with temperature. When the temperature rises, the maximum output power and open-circuit voltage decrease whilst the short-circuit current increases. Usually, when the solar PV module surface temperature increases, the module efficiency decreases.

All these literatures concluded that the efficiency of PV units decreases linearly with the increase in operating temperature. Despite the diversity and multiplicity of the methods, the devices and equipment used in practical and theoretical experiments proven that the increase in dust in the atmosphere harms the production of PV cells and lead to several problems:

- Hours and sunny days decline in general, which reduce energy production hours in turn.
- Determining the amount of dust accumulated on the solar panels has become essential to determine the extent to which dust particles can settle on the boards.
- Dust particles accumulated on the panel cause losses similar to the effect of shadows, which is caused by the irregular accumulation of dust, thereby leaving some areas unexposed to even sunlight, as if exposed to the shades.

## 2. System description and experimental setup

The experimental investigation was conducted in Diyala, Iraq, in the middle of the country at latitude and longitude ( $33.7733^{\circ}$  N,  $45.1495^{\circ}$  E). The PV module tilt angle is  $\beta = 30^{\circ}$ , and the azimuth angle is  $\gamma = 0^{\circ}$  to the south of the horizon. This experiment used an Arduino Mega 2560.

The system consists of 10 main components, including two PVs, two solar charge controllers, two batteries, two loads (lamp), four temperature sensors, Arduino board, Internet modem, data logger, monitoring system and Wi Fi, as shown in the system layout used in the experiment in Figure 1.

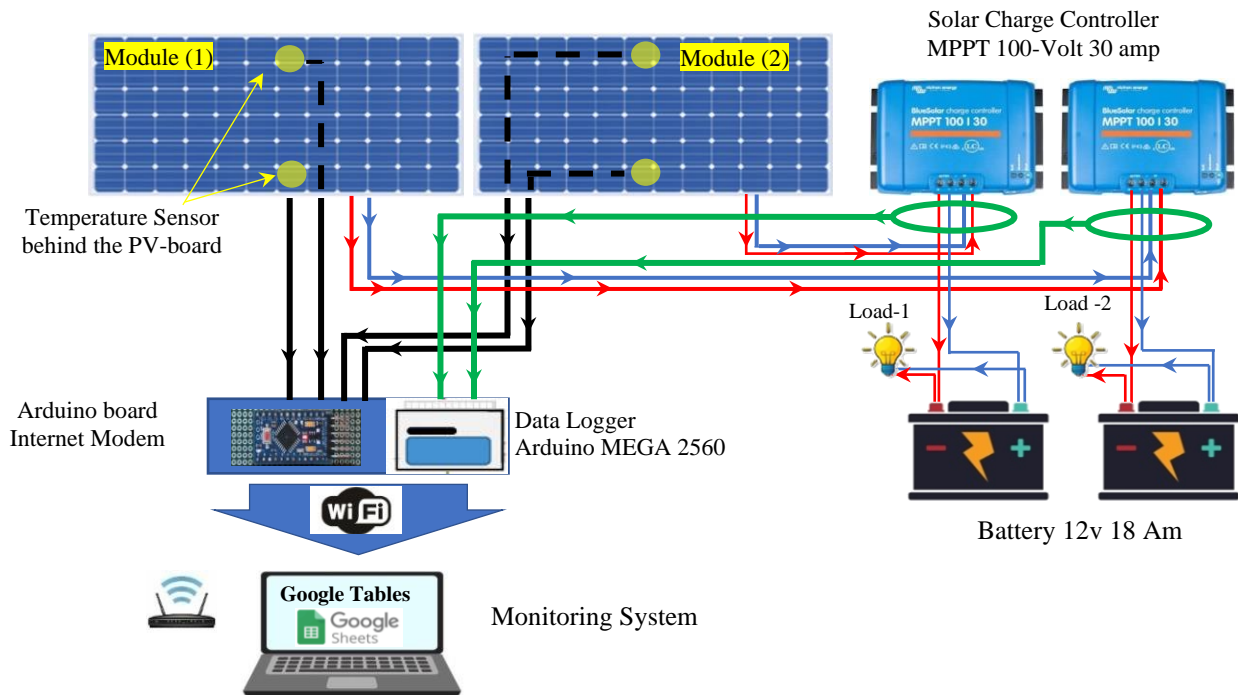

**Figure 1.** The system layout used in the experiment

### 2.1 Solar charge controller

Each PV module is coupled to an inverter with a maximum power point tracker (MPPT), which is subsequently coupled to the battery and lamp. The PV, which is stored in the battery and utilised by the lamp, provides energy throughout the day. At night, when the PV module is not generating power, the battery is used to power the lamp, as shown in Figure 2.

MPPT has connected to the mobile via a programme (Victron Connect) to show the

daily, weekly and monthly data for each PV module production quantity, including the voltage and current for solar and battery cells. This approach helped calibrate the system and verify the validity of the data extracted from the Arduino. This program has unique graphs between the generated and consumed energy that facilitate comparison and the validity of the results. In this work, Arduino's results mainly relied on its calibration using the MPPT program (Figure 3).



Figure 2. The solar charge controller

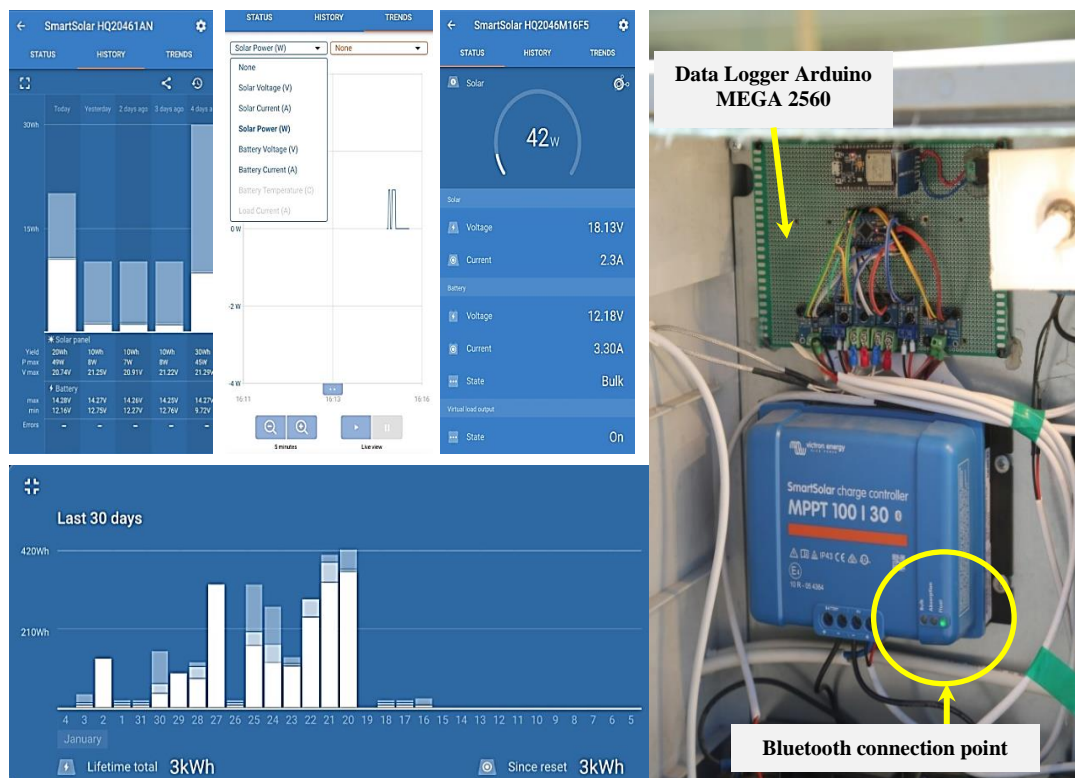

Figure 3. MPPT system output

## 2.2 Storage (Battery)

Sealed lead–acid battery was used (PT18-12 12V18AH) and connected with a solar charge controller on one end and loaded (load) on the other, and it has a depth of discharge that allows it to charge and discharge slowly repeatedly. The specifications of the module are presented in Table 1. When the proposed system included two batteries connected to the MPPT device and four lamps with a capacity of 55 and 20 watts for each design, the battery is calibrated daily using the Victron Connect software application to ensure that it is working well and

has no shortening in the amount of current supplied.

Table 1. the modules specifications of battery

Cycle USE	14.6~14.8V(25°C)
Standby USA	13.6~13.8V(25°C)

## 2.3 Load (lump)

The proposed system is equipped with two types of lamps, and the first category is 55 W. The second category is 20 W with the same quantity of 2 units for everyone. These lamps (e.g. 55 W and 20 W) have been connected for



every system until it is forced to generate as much as possible. The lamp is on for 24 h, thereby making it the energy consumer (load). The PV provides energy throughout the day, which is stored in the battery and utilised by the lamp. At night, when the PV module is not generating power, the battery is used to power the lamp.

### 2.4 Digital temperature Sensor

The temperature sensors of type N MAX6675, 100×59×20 mm, the resolution of

the thermosensor is  $\pm 0.25\text{ }^{\circ}\text{C}$ . The Arduino-based temperature monitor measured temperatures between  $(-50\text{ }^{\circ}\text{C}$  and  $370\text{ }^{\circ}\text{C})$ . Before beginning work, it has been calibrated and placed on the back PV modules at the (top and bottom). It was separated by insulating tape to enable precise readings of the operational temperature without the effect of ambient tempera. Figs. 4–5 illustrate the digital temperature sensors for system-3 used in Model 2.

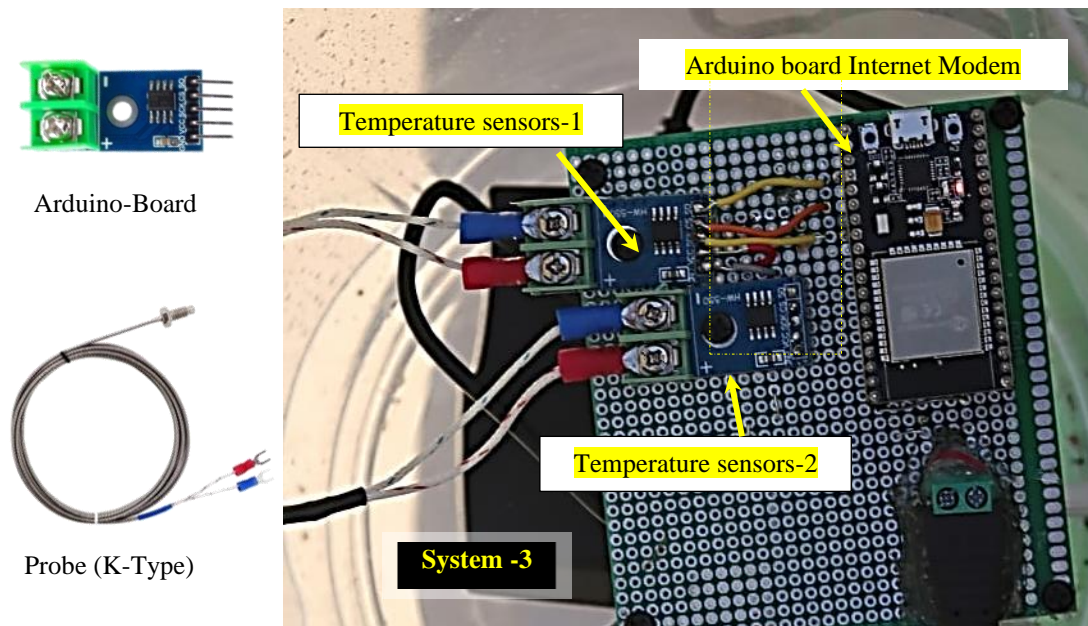

Figure 4. Battery and Load system

### 3. Proposed PV modules specifications

In this experiment, the proposed PV panel modules that used two units were positioned on the roof of the Department of Mechanical Engineering Building of Engineering College/Diyala University. Table 2 shows the specifications of the proposed module.

Figure 5 shows that the selected building consists of two floors with a maximum height of 6 m without any shade on the PV modules during the whole day for the investigated period (December 2021 to April 2022).

Table 2. The specification of proposed PV modules.

Model	Rated Power
Rated peak power ( $P_{max}$ )	150 W (peak)
Rated current ( $I_{mp}$ )	8.31
Rated voltage ( $V_{mpp}$ )	18.10 V
Short circuit current ( $I_{sc}$ )	8.72 A
Open circuit voltage ( $V_{oc}$ )	22.50 V
Module efficiency (%)	20%

#### 4. Experimental data recoining

Figure 1 depicts the experimental circuit for the proposed system, whereas Figure 5 depicts the experimental component and connections for the proposed system. Each PV module is coupled to an inverter with a maximum power point tracker (MPPT), which is subsequently coupled to the battery and the lamp. The lamp is on for 24 h, thereby making it the energy consumer (load). The PV provides energy throughout the day, which is stored in the battery and utilised by the lamp. At night, when the PV module is not generating power, the battery is used to power the lamp. The back of each module has two thermocouples installed in the centre (top and bottom) for temperature recoding.

Each system is linked to the data logger contained inside the Arduino MEGA 2560

(Figure 5). The microcontroller board of the Arduino Mega type features (54) digital input/output ports, (15) analogue inputs, (16) UARTS and (4) hardware serial ports. A crystal oscillator operates at 16 MHz, a USB port, a power jack, an ICSP header, and a reset button. This card may be powered and linked to a computer via a USB connection, an AC-to-DC converter or a battery. The Arduino (1.8.19) software was connected to the Internet to obtain the data for a programme that transfers the information into Google Sheets (BETA).

Three output measurements (e.g., voltage, current and power) were taken for each of the two PV models. These measurements assign and store data (voltage, current, and power) from the two solar panels whilst recording the temperature of the first PV model. Meanwhile, the second card captures the temperature of the second PV panel alone.

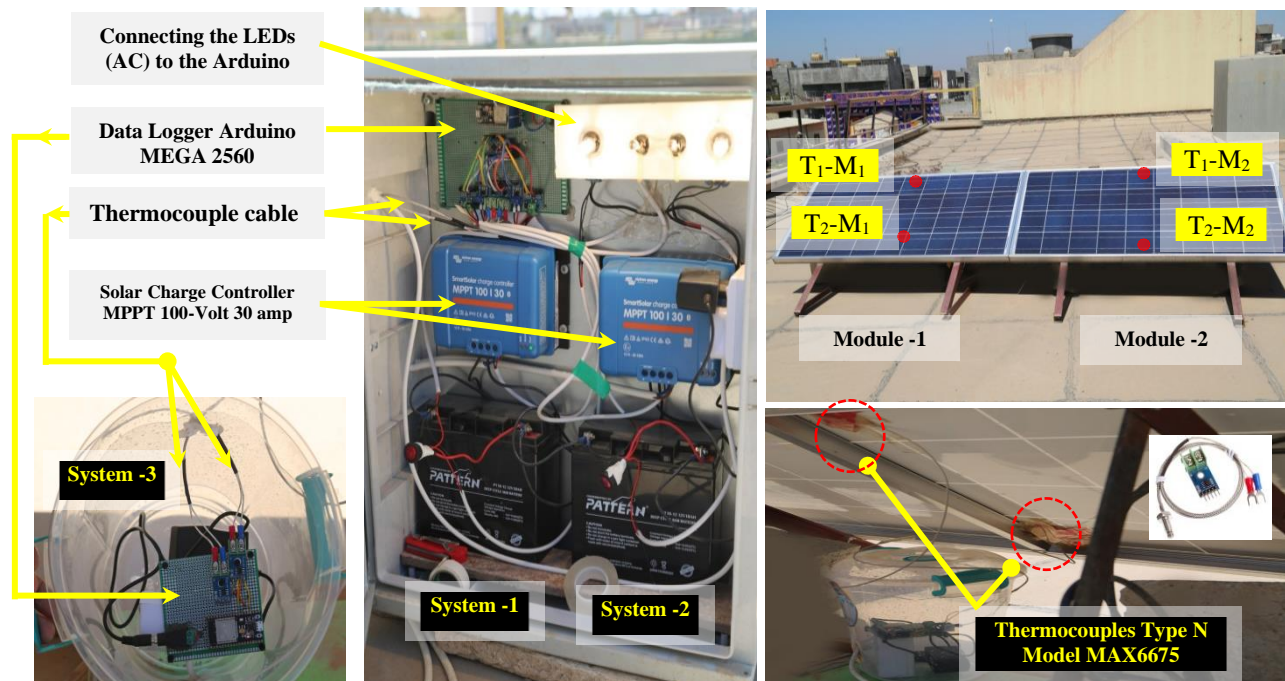
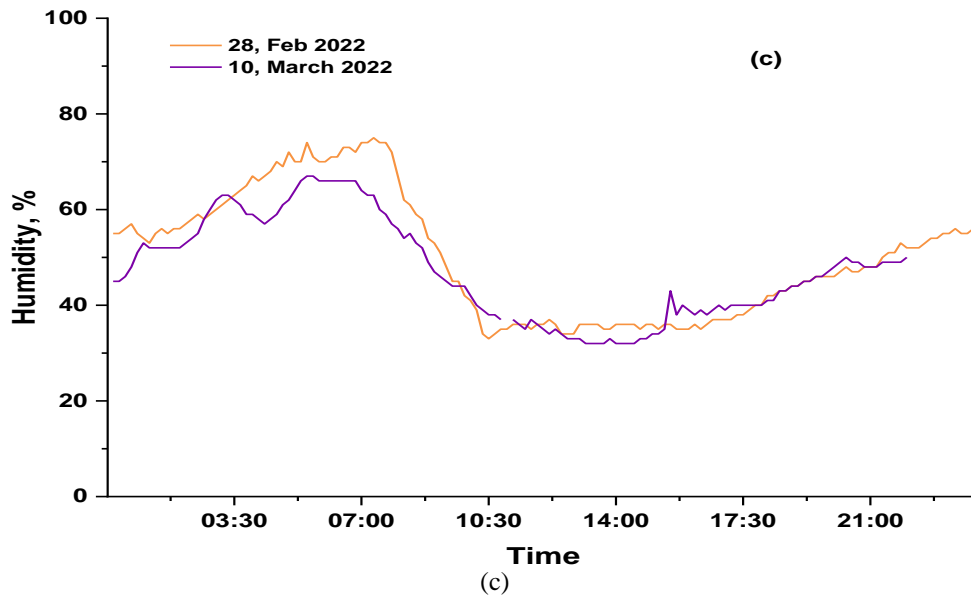
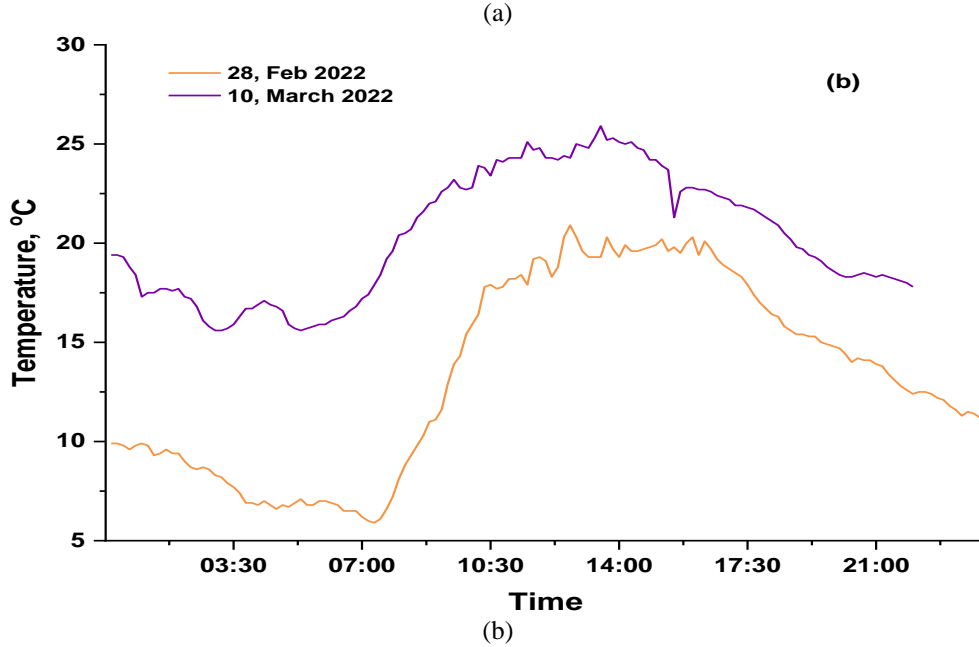
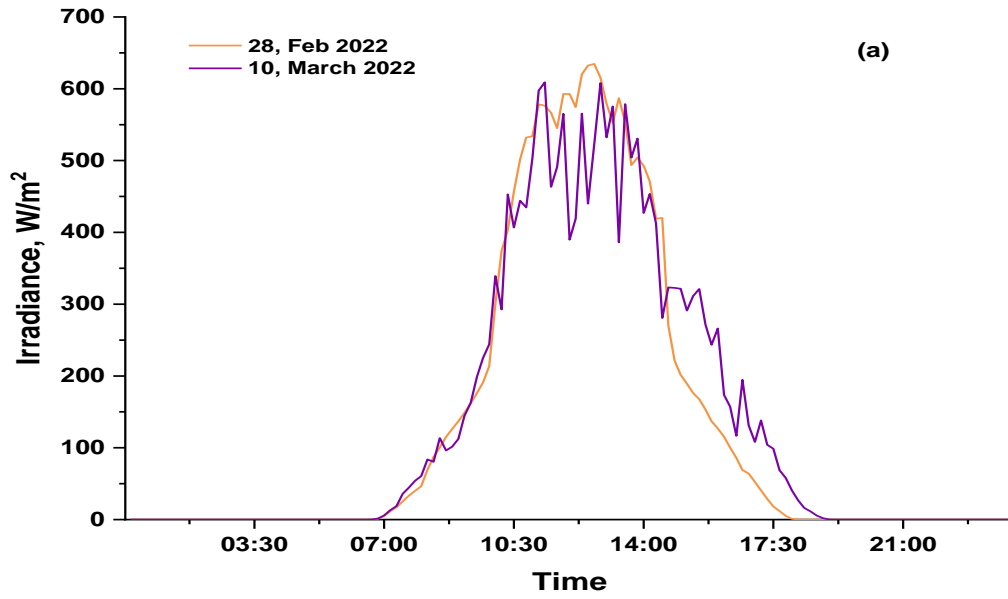

Figure 5. The experimental modules and controller systems

The experimental weather data have been collected at a 1-minute resolution from the weather station located at the same site. Figure 6 shows the solar irradiance, ambient

temperature, air humidity and wind speed for the two selected days (i.e., February 20 and March 10 of 2022).





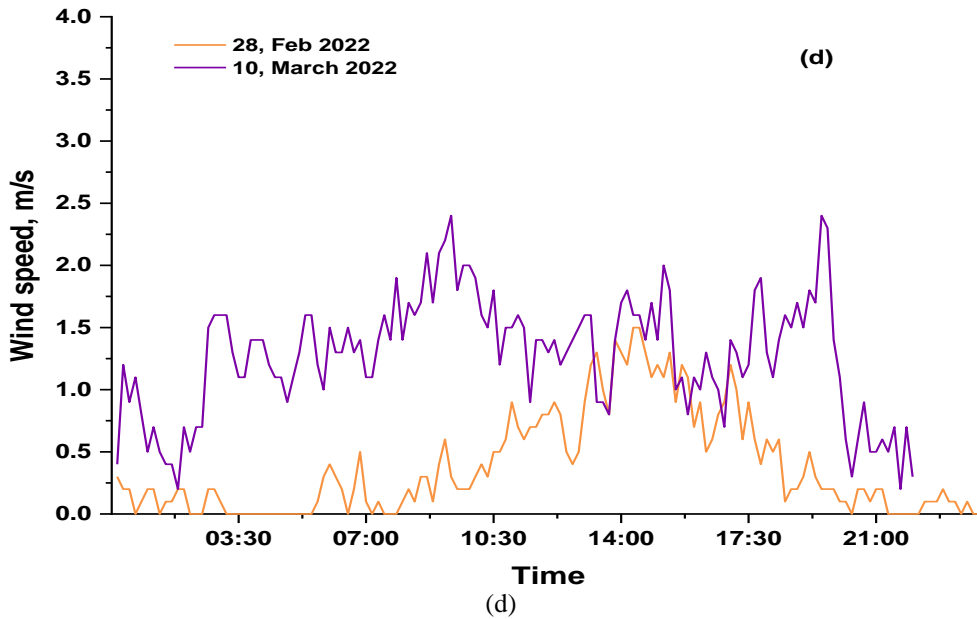

Figure 6. The experimental weather data measurements, (a) Solar irradiance, (b) ambient temperature, (c) air humidity and (d) wind speed

### 5. Impact of temperature on PV module

The experimental measurements for the temperature of PV cells have been executed and compared with the model described in Equations 2. These various methods estimate the temperature of the PV cells by assuming that the back surface temperature is identical to the temperature of the PV cells. In our case, the temperature of both solar modules was determined using these models. Then, we provide the climate-appropriate model for the Diyala area. The power generated by the PV module can be presented as [29]:

$$P_{PV} = C_{PV} \eta_{PV} \left( \frac{G_T}{G_{T,STC}} \right) \left[ 1 + \alpha_p (T_C - T_{C,STC}) \right] \quad (1)$$

Where  $C_{PV}$  is the PV module capacity,  $\alpha_{PV}$  is the PV array capacity derating factor (%),  $G_{T,STC}$  is the solar radiation at STC (Standard Conditions) ( $\text{kW}/\text{m}^2$ ),  $G_{T,t}$  is the incident solar radiation ( $\text{kW}/\text{m}^2$ ),  $\alpha_P$  denotes the PV cell temperature coefficient of power ( $\%/^{\circ}\text{C}$ ) [35,36],  $T_{C,t}$  is the PV cell temperature ( $^{\circ}\text{C}$ ) and  $T_{C,STC}$  is the PV cell temperature ( $^{\circ}\text{C}$ ) at STC. The model for predicting PV cell temperature using ambient temperature, solar irradiance and wind speed presented in [30] as:

$$T_C = T_a + R_k G_T + e^{(3.75 - 0.75V_w)} \quad (2)$$

Where  $R_k$  is the Ross coefficient range 0.02–0.04 ( $\text{Km}^2/\text{W}$ ),  $T_a$  is the ambient temperature ( $^{\circ}\text{C}$ ),  $T_C$  is the PV module instantaneous temperature ( $^{\circ}\text{C}$ ),  $V_w$  is the wind speed (m/s),  $\alpha_p$  is the module temperature coefficient of power ( $\%/^{\circ}\text{C}$ ).

### 6. Results and discussion

In the present research, experimentation was conducted for five months, that is, from December 1, 2021 to April 30, 2022. Performance loss (power, current and voltage) was explored. The voltage losses increased by 18.9% as the temperature rises from 9.25  $^{\circ}\text{C}$  to 50.5  $^{\circ}\text{C}$ , and the amount of dust rose from 0.144  $\text{g}/\text{m}^2$  to 0.3  $\text{g}/\text{m}^2$ . The current loss was greater than the reduction in voltage by 26.1%, and the reduction in power was 17.9%.

The precision of the created models is shown in Figures 7, 8 and 9. The accuracy of the models for forecasting power loss under the influence of dust at the ideal panel angle in the examined condition was worse than those models used for predicting current losses. Figures 7 and 8 depict the regression PV module temperature under the influence of dust accumulation for two selected days, namely, February 28 and March 10, 2022.

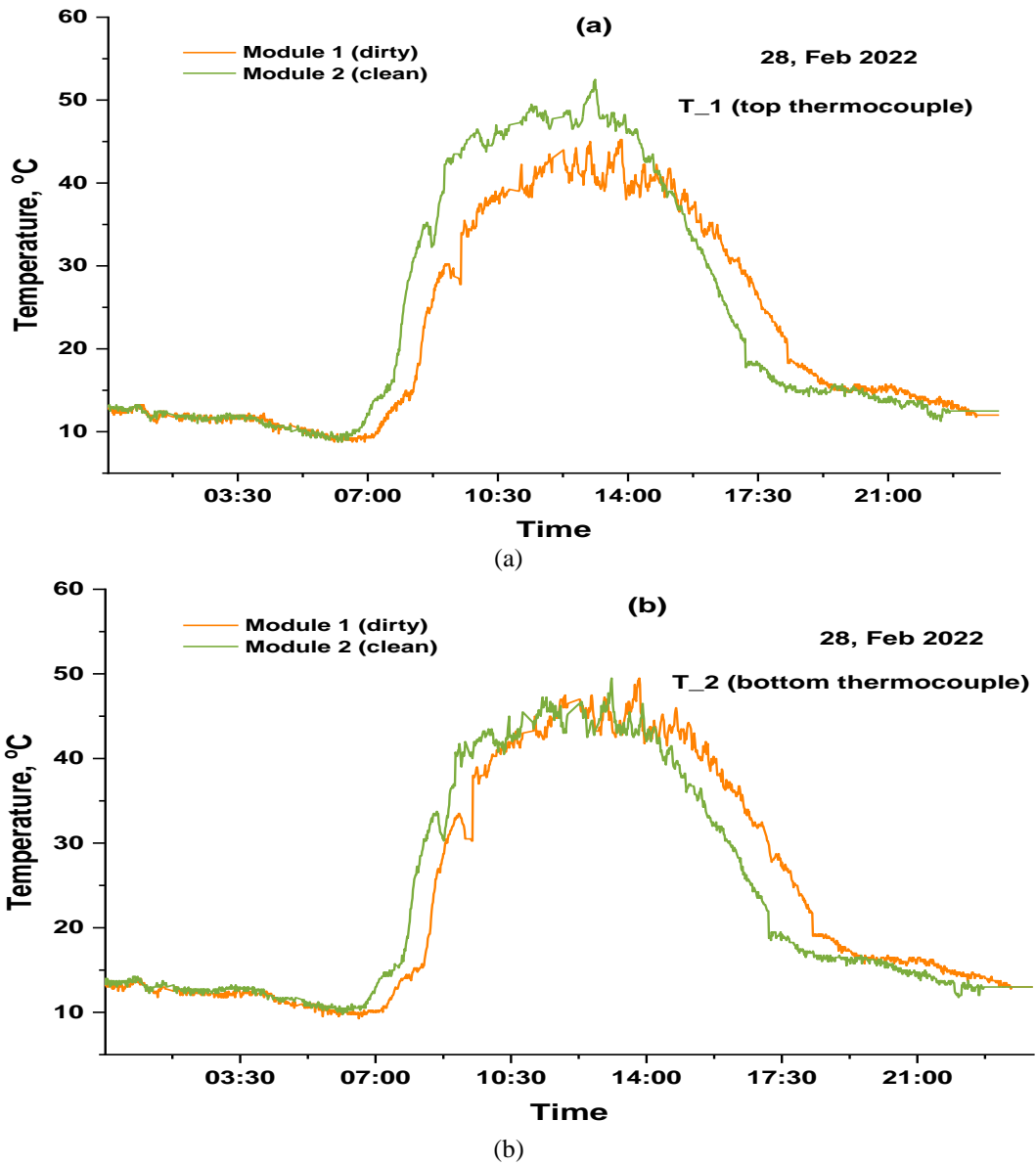
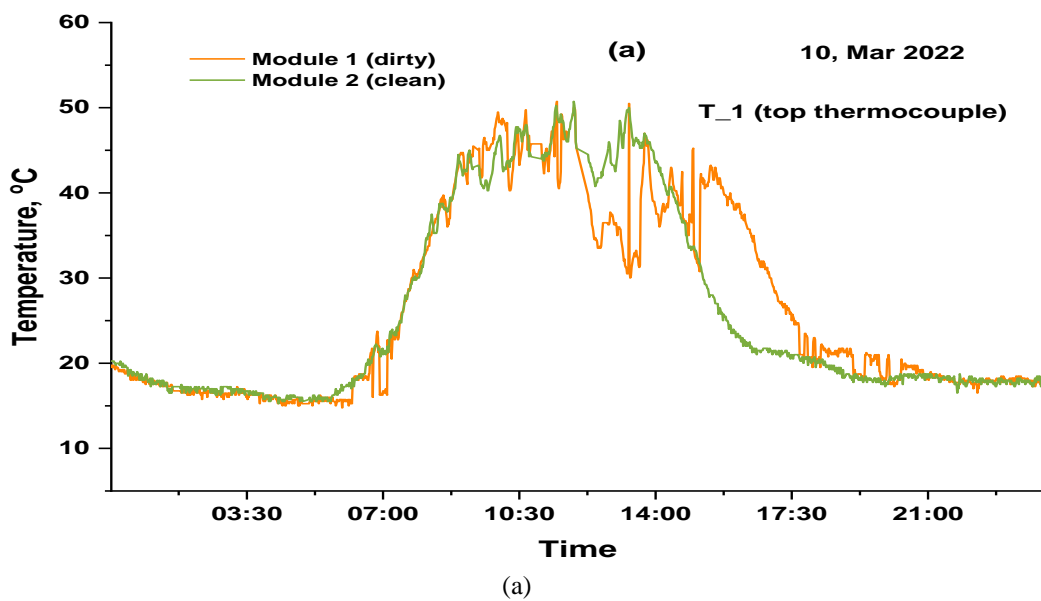
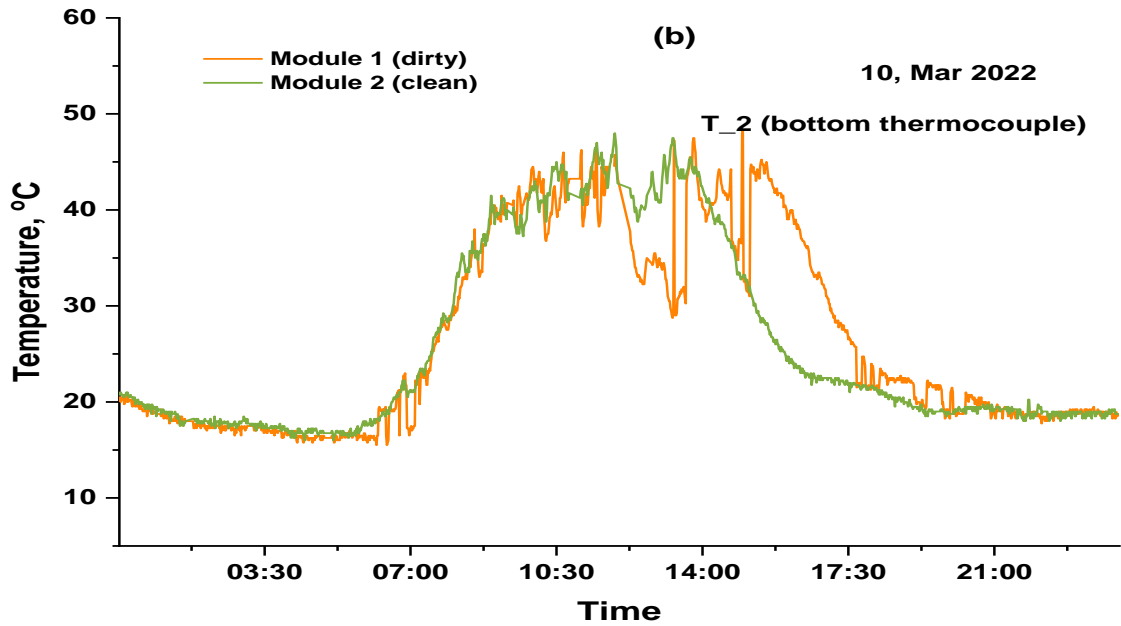

Figure 7. The PV modules experimental temperature for the day of February 28, 2022





(b)

Figure 8. The PV modules experimental temperature for the day of March 10, 2022

Figure 9 shows the PV module power degradation (a) and current degradation (b) due to the accumulated dusts for March 10, 2022.

Evidently, power and current degradation due to the accumulated dusts increased the power and current degradation, respectively.

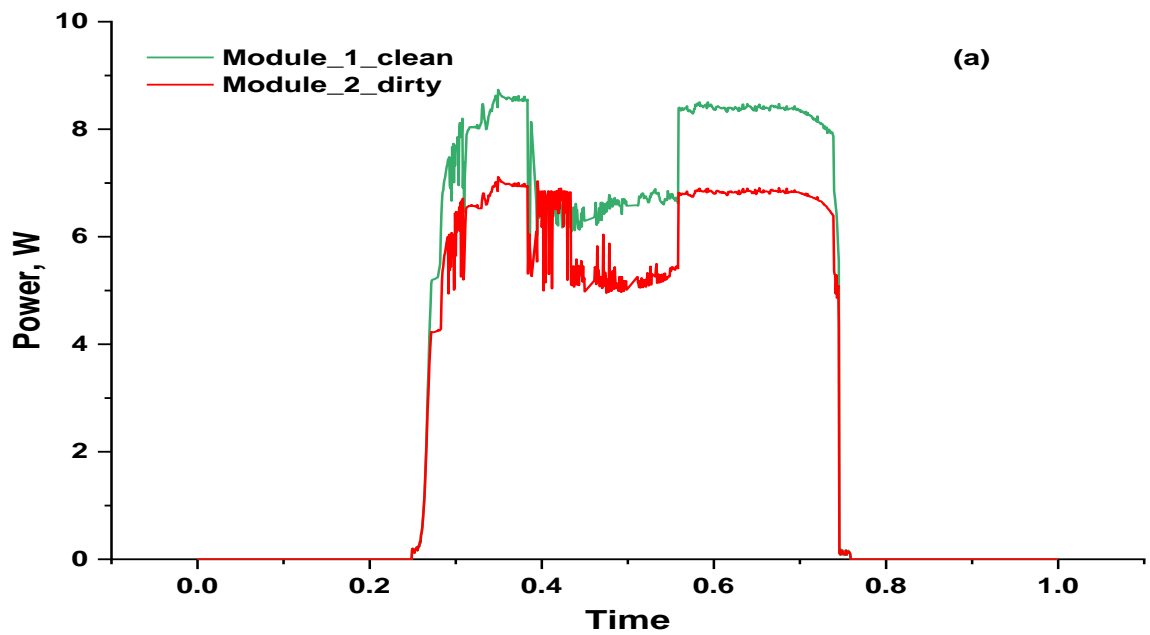

(a)

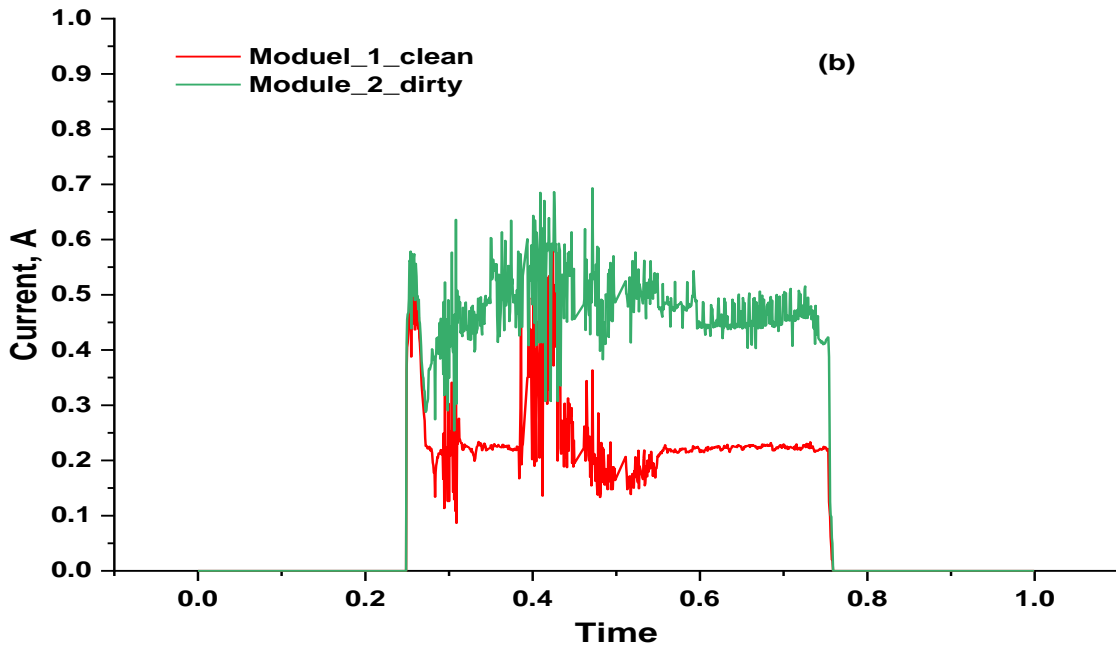

(b)  
**Figure 9.** The PV modules experimental (a) power in (b) current for the day of March 10, 2022

The estimation factor of the existing loss models is shown in Figures 10–12, which displays the power, voltage and current. Based on a dust deposition range of 0.14 to 0.3 g/m<sup>2</sup>,

the proposed module power loss ranged from 11% to 17%. The power loss polynomial model of the second order had a high accuracy of 84.72% (Figure 10) 10.

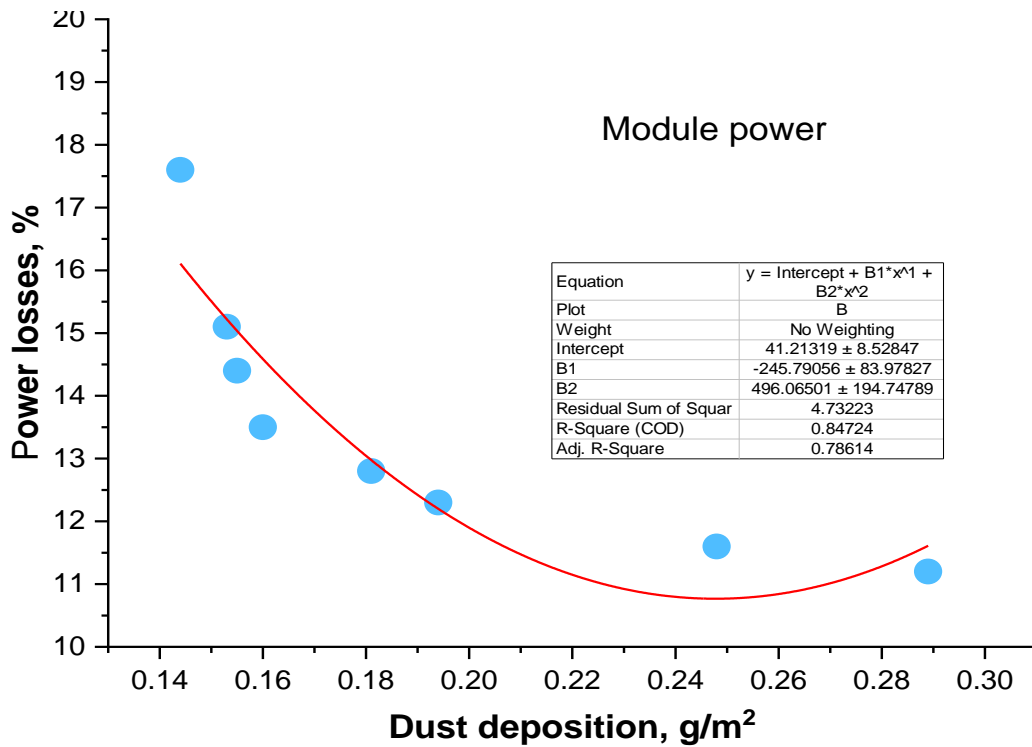

**Figure 10.** The power polynomial loss models of the dusty PV module

Figure 11 displays the module voltage loss results at various dust concentrations, ranging from 0.14–0.3 g/m<sup>2</sup>, and temperatures of 14°C–53°C. The voltage loss in the modules ranged from 14.1% to 18.9%.

The amount of voltage loss due to dust accumulation and module temperature is exactly proportional to the amount of current and voltage losses (Figures 11 and 12). In addition, the quantity of power lost in the panels affects efficiency loss. In all regression models, the polynomial model had a higher

determination coefficient than the other models because when the quantity of dust deposited on the PV module increases, the voltage, current and power loss increase fast at first and then with a decreasing slope until they approach a constant value. In other words, if the quantity of dust is above a particular threshold, the voltage, current, and power loss will not vary greatly; however, at the maximum level of dust (0.3 g/m<sup>2</sup>), the output power reduces dramatically, and the panel loses efficiency virtually.

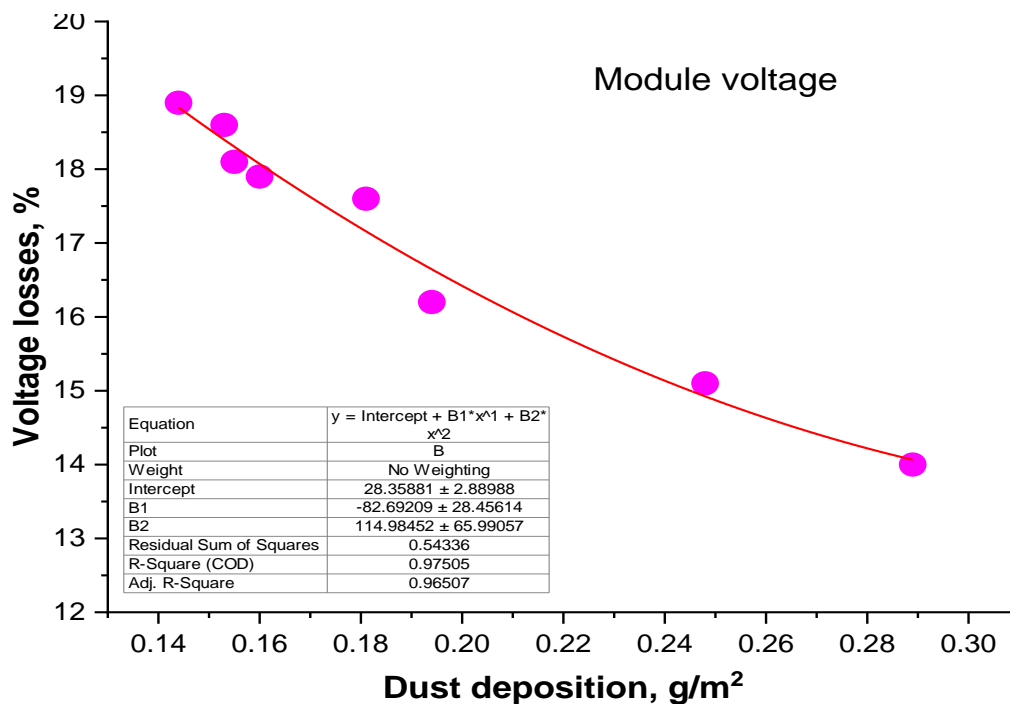

Figure 11. The voltage polynomial loss models of the dusty PV module

The effect of the dusty PV module increased with the value of the deposited dust (Figures 10–12). When irradiance hits the PV module, it imparts additional energy to its electrons, thereby causing them to become polarised and therefore locating the negative electrons in the silicon. Thus, a potential difference is created

between the two electrodes, which results in the flow of current between them.

When more dust exists on the panel surface, the electrons cannot absorb as much solar energy, thereby making the module less effective.



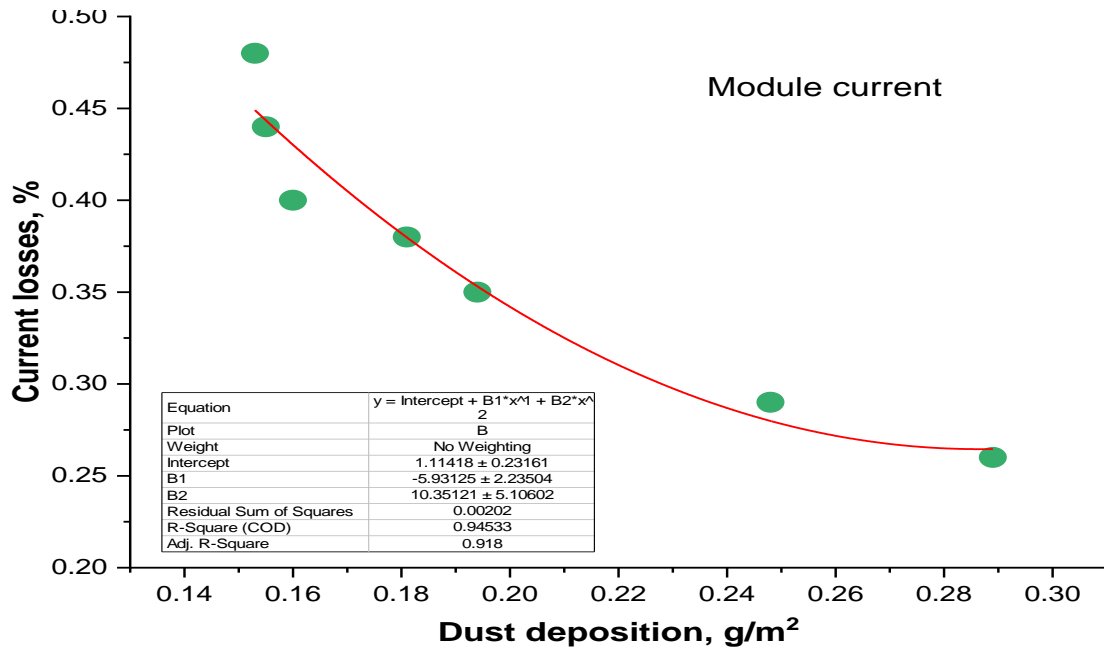

**Figure 12.** The current polynomial loss models of the dusty PV module

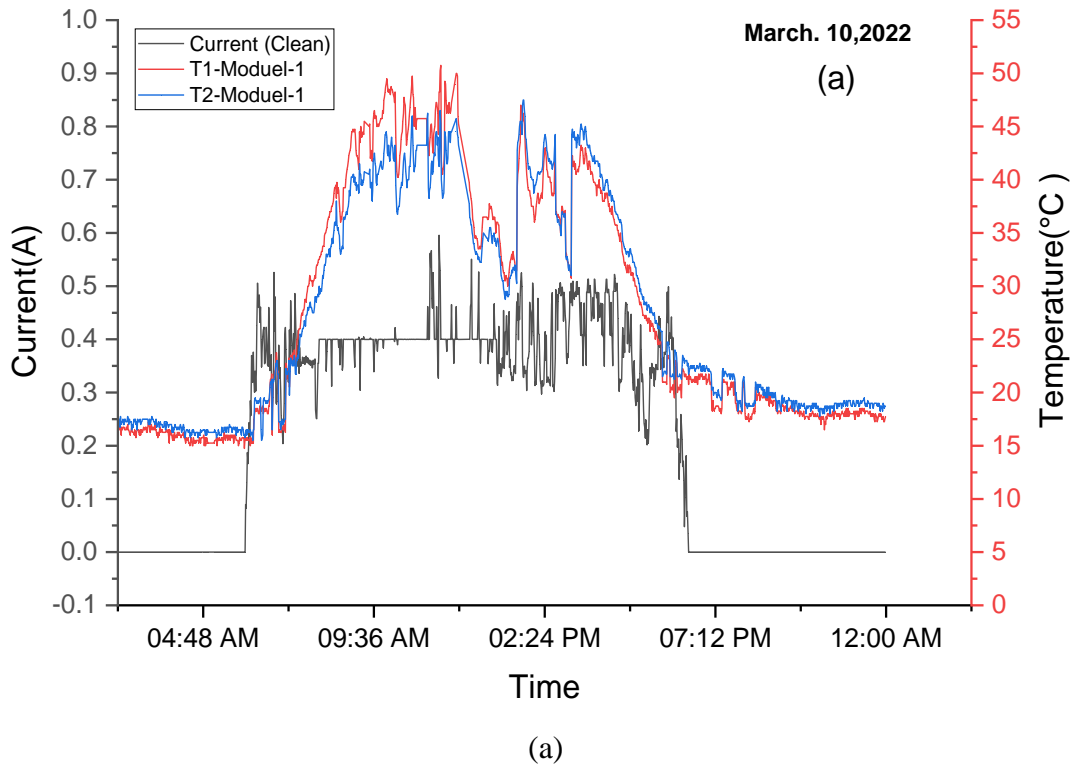

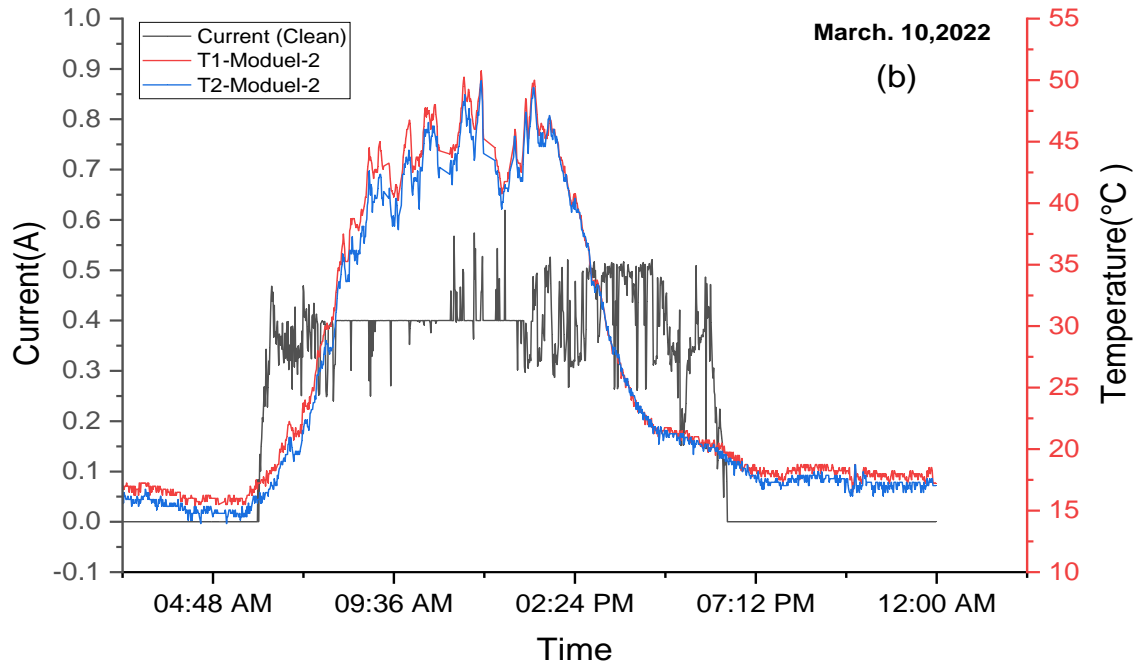

**Figure 13.** The behaviour of current against the temperature (a) for modeal (1-Clean), (b) for modeal (2-Clean)

Figure 13 shows the effects of increasing the temperature on the solar cell (silicon), namely, negative performance and efficiency. As the temperature increases, the current rises slightly, and the cell voltage decreases even more; thus, the production capacity and efficiency decrease. The sensitivity of solar cells to heat varies according to the technology used. Thin film cells are less affected by heat than monocrystalline cells.

Semiconductors are sensitive to heat. Thus, increasing the temperature reduces the band gap and affects the semiconductor parameters. When the energy of the electrons increases and breaking the bond between the electrons and the nucleus decreases, the current increases, and the voltage decreases when the temperature rises. Furthermore, the solar cell equations confirm this finding.

Thus, the PV module power, current, and voltage loss increased with higher speed for lower dust values and lower temperatures and then decreased for higher dust values, so that they reach a constant loss value at the highest dust level.

## 7. Conclusions

In this article, the influence of temperature and dust accumulation on the outdoor performance of PV modules was investigated by monitoring the voltage, current and power of clean and dusty modules continuously for approximately five months in North-eastern Iraq. The ideal cleaning time for a utility scale PV module was determined on the basis of the collected data and modelling tools. As a consequence, the following conclusions have been drawn:

- Voltage, current and power loss increased based on the amount of dust collected on the panel. Prior to reaching a constant value, the rate of increase for low dust concentrations was high and declined as the dust concentration increased.
- Although dust had the least impact on the module voltage, it had a significant impact on the module current and, therefore, its power. The modelling findings of voltage, current and power loss under the influence of deposited dust revealed that the determination coefficient of the quadratic model was greater than those of other models, thereby suggesting the quadratic's

superior capacity to forecast voltage, current and power loss. Given that the cleaning operations of solar panels must be performed with a predetermined performance loss, the models must be developed to predict the performance loss in the panels.

- The power loss of a contaminated module was polynomial and reduced with time. In this respect, polynomial models are superior to linear and power relations for predicting temperature and soiling efficiency loss in PV modules. To acquire more accurate estimates of the constants used in the suggested models, more tests should be conducted at the test location.
- According to the experimental results, different design parameters can be used to improve the performance of these solar panels by changing the installation angles, their relationship with wind and the rise in the incidence of solar radiation at the installation site.
- As a result of climatic changes and the increase in dust storms (dust sources), which increased the deposition of dust on solar panels for long periods and could not be removed naturally by wind and rain, several measures had to be considered to address this problem, including:
  - Avoiding the installation of solar energy systems in areas where human activities abound, such as drilling and construction, especially if high monsoon winds are present.
  - Considering environmental factors, such as wind speed, humidity, frequency of dust storms, temperature and other elements.
  - Considering the effectiveness of installing systems in agricultural areas, because it works to reduce temperatures and soften the atmosphere that surrounds the system.
  - The results have proven that the natural cleaning of solar panels, especially for small systems, is highly effective in improving production.
  - In the case of large systems, the use of robots that do not infect cells in a scheduled manner or specific mechanical devices is possible.

The use of wheels equipped with water or air hoses to clean the panels, which helps reduce temperatures, considering the careful cleaning is also possible.

## References

- [1] U. Pillai, "Drivers of cost reduction in solar photovoltaics," *Energy Economics*, vol. 50, pp. 286-293, 2015.
- [2] L. Strupej and L. Neij, "Cost dynamics in the deployment of photovoltaics: Insights from the German market for building-sited systems. *Renewable and Sustainable*," *Energy Reviews*, vol. 69, pp. 948-960, 2017.
- [3] M. Hadjipanayi, I. Koumparou, N. Philippou, V. Paraskeva, A. Phinikarides, G. Makrides and G. E. Georghiou, "Prospects of photovoltaics in southern European, Mediterranean and Middle East regions," *Renewable Energy*, vol. 92, pp. 58-74, 2016.
- [4] E. Skoplaki and J. A. Palyvos, "On the temperature dependence of photovoltaic module electrical performance: A review of efficiency/power correlations," *Solar energy*, vol. 83, pp. 614-624, 2009.
- [5] A. R. Amelia, Y. M. Irwan, W. Z. Leow, M. Irwanto, I. Safwati and M. Zhafarina, "Investigation of the effect temperature on photovoltaic (PV) panel output performance," *Int. J. Adv. Sci. Eng. Inf. Technol*, vol.5, pp. 682-688, 2016.
- [6] J. L. Bryan, T. J. Silverman, M. G. Deceglie and Z. C. Holman, "Thermal model to quantify the impact of sub-bandgap reflectance on operating temperature of fielded PV modules," *Solar Energy*, vol. 220, pp. 246-250, 2021.
- [7] H. Mohammed, M. Kumar and R. Gupta, "Bypass diode effect on temperature distribution in crystalline silicon photovoltaic module under partial shading," *Solar Energy*, vol 208, pp.182-194, 2020.
- [8] N. H. Zaini, M. Z. Ab Kadir, M. Izadi, N. I. Ahmad, M. A. M. Radzi and N. Azis, "The effect of temperature on a mono-crystalline solar PV panel," In 2015 IEEE Conference on Energy Conversion (CENCON) (pp. 249-253). 2015
- [9] Z. H. Ali, K. A. Abdullah and A. T. Saeed, "Modeling solar modules performance under temperature and solar radiation of Western Iraq," *International Journal of Power Electronics and Drive Systems*, vol. 9, pp. 1842-1850, 2018.
- [10] Z. A. Darwish, H. A. Kazem, K. Sopian, M. A. Alghoul and M. T. Chaichan, "Impact of Some

Environmental Variables with Dust on Solar Photovoltaic (PV) Performance: Review and Research Status,” Issue 4, vol. 7, PP. 152-159, 2013.

- [11] M. T. ChPP.aichan, B. A. Mohammed, H. A. Kazem, “Effect of pollution and cleaning on photovoltaic performance based on experimental study,” *International Journal of Scientific & Engineering Research*, Volume 6, Issue 4, April-2015 594 ISSN 2229-5518.
- [12] H. A. Kazem, M. T. Chaichan, “Effect of environmental variables on photovoltaic performance-based on experimental studies,” *International Journal of Civil, Mechanical and Energy Science*, vol. 2, pp. 1-8, 2016.
- [13] A. A. K. Al-Waeli, K. A. Al-Asadi and M. M. Fazleena, “The Impact of Iraq Climate Condition on the Use of Solar Energy Applications in Iraq: a Review,” *International Journal of Science and Engineering Investigations*, vol. 6, p. 68, 2017.  
[www.IJSEI.com](http://www.IJSEI.com).
- [14] A. Gholami, I. Khazaei, S. Eslami, M. Zandi and E. Akrami, “Experimental investigation of dust deposition effects on photovoltaic output performance,” *Solar Energy*, vol. 159, pp. 346–352, 2018.
- [15] M. Mostefaoui, A. Ziane, A. Bouraiou and S. Khelifi, “Effect of sand dust accumulation on photovoltaic performance in the Saharan environment: southern Algeria (Adrar),” *Environmental Science and Pollution Research*, vol. 26, pp. 259–268, 2019.
- [16] H. A. Kazem, M. T. Chaichan, A. H. A. Al-Waeli and K. Sopian, “A novel model and experimental validation of dust impact on grid-connected photovoltaic system performance in Northern Oman. *Solar Energy*, vol. 206, pp. 564–578, 2020.
- [17] H. A. Kazem, M. T. Chaichan, A. H. A. Al-Waeli and K. Sopian, “A review of dust accumulation and cleaning methods for solar photovoltaic systems,” *Journal of Cleaner Production*, vol. 276, 10 December 2020, 123187.
- [18] Q. Hassan, B., Jaszczur, M., Al-Jiboory, A. K. Hasan and A. Mohamad, “Optimizing of hybrid renewable photovoltaic/wind turbine/supercapacitor for improving self-sustainability,” *Energy Harvesting and Systems*. Article in press.
- [19] M. Jaszczur1, Q. Hassan, J. Teneta, E. Majewska and M. Zych, “An analysis of temperature distribution in solar photovoltaic module under various environmental conditions” *MATEC Web of Conferences* 240, 04004 (2018).