

A Parametric Study on Behavior of Elliptical Cantilever Deep Beams

Baidaa N. Hasan^{1*}, Khattab S. Abdul-Razzaq¹ and Adham Abdulsattar Hameed²

¹Department of Civil Engineering, University of Diyala, 32001 Diyala, Iraq

²Belgorod State Technological University named after V.G. Shukhov, Russia

ARTICLE INFO

Article history:

Received June 27, 2022

Accepted August 9, 2022

Keywords:

Parametric study
Reinforced concrete
Cantilever
Deep beams
Finite element

ABSTRACT

This parametric study used finite element method (ETABS 2019), on 20 elliptical reinforced concrete cantilever deep beam specimens that have rectangular sections. Five parameters were taken into consideration: beam height, beam width, concrete compressive strength, load position and load type. Results showed that when the beam height was increased by 12%–66.5%, the negative and torsional moments and load capacity increased by about 11.23%–76.33%, 11.2%–77% and 11.1%–78%, respectively, whereas deflection decreased by about 15%–39%. The negative and torsional moments and load capacity increased by 26.13%–166.53%, 27%–172.5% and 28%–180%, respectively, and a decrease in deflection of about 1.73%–2.3% took place when beam width increased by about 14.3%–81%. In addition, increasing the compressive strength of concrete by 7.5%–36% led to an increase in the negative moments, torsional moments, load capacity, and deflection by about 8.22%–19.2%, 8.7%–20.4%, 9.4%–22% and 4.7%–7.1%, respectively. When changing the load type from concentrated to uniformly distributed over a third of the span's length, two-thirds of the span's length and then over the full span's length, the negative moments increased by 5.23%, 8.47% and 52.67%, whereas torsional moments decreased by 1.1%, 1.12% and 16%, respectively. Finally, placing the concentrated load at a distance of 0.75, 0.5 and 0.25 of the span lengths led the negative moments to increase by 56.9%, 102.3% and 110%, respectively, whereas torsional moments decreased by 8.64%, 25%, and 58.3%, respectively. The load capacity increased by 87.5%, 243.75% and 556.25%, respectively, accompanied by a decrease in the deflection of the free end by 3.24%, 17.65% and 49.8%, respectively.

1. Introduction

Elliptical reinforced concrete beams are required when constructing elliptical reservoirs, balconies and foundations because of the structural need as well as their aesthetic curvature [1]. Shear and flexural stresses are present in the reinforced concrete beam. Owing to its curvature, another type of stress is added, which is the torsional stress. It appears due to the mismatch between the loading and supporting points on one straight line. In other words, the state of the stresses is more complicated when the curvature is present in the elliptical beam

especially when the curvature is variable. The elliptical beam has two axes, one large (major) and one small (minor), so the symmetry of the circular ring beam is lost.

The American code ACI 318–19 summarises the definition of deep beams in the following text [2]: ‘the beams that are supported on a face and loaded on the opposite face as shear stresses can form between the loads and supports. That must satisfy (1) or (2): (1) concentrated loads occurred in a displacement twice the beam depth (2 h) from face of support; and (2) clear span is not more than four times h’. The authors noted that most of the research

* Corresponding author.

E-mail address: baidaa.1996.bb@gmail.com

DOI: [10.24237/djes.2022.15403](https://doi.org/10.24237/djes.2022.15403)

on parameters affecting the behaviour of deep members dealt with simply supported deep beams [3–6] and continuously supported deep beams [7–11], but not with elliptical cantilever deep beams. For this reason, the current research is conducted.

For the analysis and design of reinforced concrete deep beams, finite element method is an approved tool [12–18]. After reviewing the aforementioned research, the authors found that increasing the height and width of the beam section or the compressive strength of concrete, or even changing the type of loading from a central concentrated load to a uniformly distributed one, in simple or continuous deep beams, leads to an increase in their load capacity with a significant decrease in deflection. This finding motivated the authors to study the cantilevered elliptical deep beams to find out the specific proportions of these effects. Although the cantilevered elliptical beams are important from a structural and aesthetic perspective, the authors did not find studies on them. To determine the effects of beam height, beam width, concrete compressive strength, load type and load position on negative bending moments, torsional moments, endspan deflection, load capacity and failure location, the authors performed analytical investigation for 20 reinforced normal concrete elliptical cantilever deep beams.

2. Modelling via finite element method

This research looked at the parametric impact on elliptical cantilever deep beam specimens by utilising the ETABS 2019 software. The entire process is broken down into the steps listed below.

2.1 Modeling

The three-dimensional (3D) linear finite element method was adopted to model the 20 cantilever deep beam specimens to study the most influential parameters affecting their behaviour. Every specimen was divided into 190 finite elements. This number of finite elements was carefully studied and determined to save time and effort with regard to calculations whilst maintaining the accuracy required for this work. Note that the beams were designed based on the American concrete code ACI 318–19 as a cantilever beam subjected to a load located at its free end, with the second end fixed in all directions. Accordingly, the main longitudinal reinforcement was positioned at the fixed end and located precisely in the upper zone of the beam section.

2.2 Finite element study cases

The 20 reinforced concrete cantilever elliptical deep beam specimens were divided into five groups: A, B, C, D and E. Each group contained four specimens and was specialised in studying only one parameter, as shown in Table 1. Four specimens from Group A, which were precisely 1000 mm, 1120 mm, 1365 mm and 1665 mm high, exhibit different height values. Four specimens from Group B, measuring 525 mm, 600 mm, 880 mm and 950 mm, exhibit different width values. Four specimens from Group C, ranging in concrete compressive strength from 30.5 MPa to 41.5 MPa, were included. In group D, how different ratios of the length of the beam span were affected was investigated by converting the loading type from a single to a uniform one. Finally, in Group E, the load was moved and placed on a quarter of the span's length (0.25 L) from the side of the fixed end, half the span's length (0.5 L) and three-quarters of the span's length (0.75 L). Figure 1 presents the elliptical deep beam in 3D modelling.

Table 1: Specimens in detail

No.	Group	Parameter		height (mm)	Width (mm)	Concrete Compressive Strength (MPa)	Load type	Load Position
1	A	dimensions	Height	1000	600	30.5	Concentrated load	1L
2				1120				
3				1365				
4				1665				
5	B	dimensions	Width	1365	525	30.5	Concentrated load	1L
6					600			
7					880			
8					950			
9	C	Material	Concrete Compressive Strength	1365	600	30.5	Concentrated load	1L
10						32.8		
11						38.5		
12						41.5		
13	D	Load type (ratio of span length (L))	Load type (ratio of span length (L))	1365	600	30.5	Concentrated load	1L
14							33%L uniform load	
15							66%L uniform load	
16							100%L uniform load	
17	E	Load Position from the fixed end	Load Position from the fixed end	1365	600	30.5	Concentrated load	0.25L
18							0.5L	
19							0.75	
20							1L	

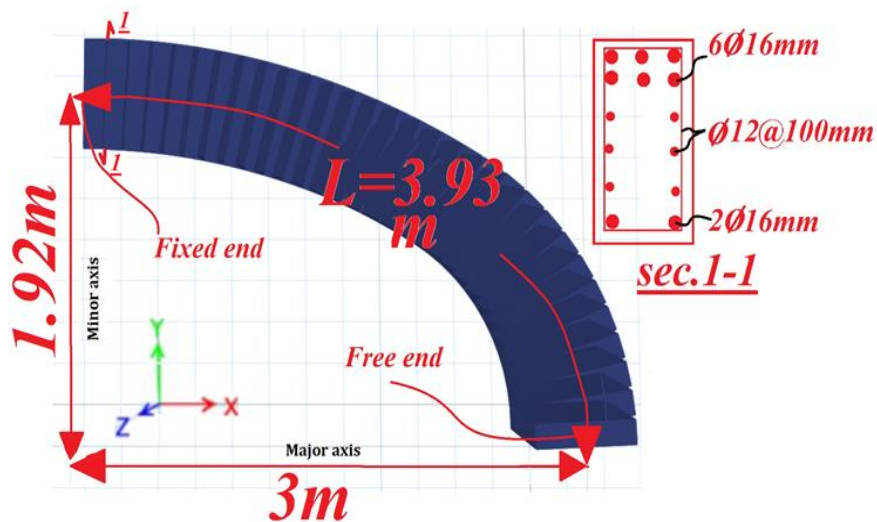

Figure 1. Cantilever elliptical deep beam

2.3 Material properties

The 20 specimens were modelled from two main materials, namely, concrete and steel. The properties of these two materials were required

in the ETABS 2019 software to feed it with real constants. The properties of concrete taken into account were compressive strength (f'_c), tensile strength (f_t), flexural tensile strength (f_{tr}), Young's modulus of concrete (E_c) and

Poisson’s ratio of concrete (ν). For steel reinforcement, the properties considered were the yield tensile strength for both main and secondary reinforcement (f_y & f_{ys}) in addition

to the Young’s modulus of steel (see Table 2). In the current study, steel was assumed to behave as an elastic of perfectly plastic material in both tension and compression.

Table 2: Material properties

Ec (MPa)	Es (MPa)	f'_c (MPa)	f_t (MPa)	Poisson’s ratio (ν)	f_y (MPa)	f_{ys} (MPa)
25956.5		30.5	3.05			
26917.5	199948	32.8	3.28	0.2	413.7	402
29162.7		38.5	3.85			
30277.6		41.5	4.15			

3. Parametric study

Table 3 presents the results of the analysis of 20 specimens with regard to the effect of beam height, concrete compressive strength, beam width, loading type (i.e., changing it from a concentrated force at the end of the beam (the free end) to a partially uniformly distributed with different percentages of the span’s length) and the load position (moving the load from the free end to the fixed end by a quarter of the

span’s length each time). In the following subsections, the effect of each of these parameters on negative moments, torsional moments, load capacity, and free-end deflection are studied in detail.

The positive and negative moments are in the direction of the longitudinal axis of the beam, whereas the torsional moments are perpendicular to it. The places where the failure occurred are explained later in some figures (when the red colour appeared on the beams).

Table 3: Detailed analysis results for all specimens

NO	GROUP	Parameter	Height (mm)	f'_c (MPa)	Width (mm)	Load type	Load Position	Fixed end M-ve (kN.m)	Max. Torsional Moment (kN.m)	Load capacity (kN)*	Change in load capacity	Deflection (mm)	Change in deflection				
1	A	Height	1000	30.5	600	Concentrated force	1L	780.79	449.7	225	-	4.7	-				
2			1120					868.44	499.97	250	11.1%	4	-14.9%				
3			1365					1104.7	637.8	320	42.2%	3.4	-27.7%				
4			1665					1376.8	795.9	400	77.8%	2.88	-38.7%				
5	B	Concrete compressive strength	30.5	1104.7	637.8			320	-	3.4	-						
6			32.8	1195.6	693.5			350	9.4%	3.56	4.71%						
7			38.5	1271	739.9			375	17.2%	3.5	2.9%						
8			41.5	1316.7	767.9			390	21.9%	3.64	7.1%						
9	C	width	1365	30.5	525			875.9	502.32	250	-	3.46	-				
10					600			1104.7	637.8	320	28%	3.4	-1.73%				
11					880			2167.3	1271	650	160%	3.52	1.73%				
12					950			2334.5	1369	700	180%	3.38	-2.31%				
13	D	Load type (ratio of span length)		600	30.5			Concentrated force	1L	1104.7	637.8	320	-	3.4	-		
14										33% U.L	1162.5	631*	1300	306%	3.34	-1.76%	
15										66% U.L	1198.3	630.9*	900	181%	3.39	-0.3%	
16										100% U.L	1686.6	535.8*	220	-31%	3	-11.8%	
17	E	Load Position			1365	30.5	Concentrated force			1L	0.75L	1733.5	582.7	600	87.5%	3.29	-3.24%
18											0.5L	2234.5	476.5	1100	243.8%	2.8	-17.7%
19											0.5L	2318.8	266.2	2100	556.3%	1.71	-49.8%
20											0.5L	2318.8	266.2	2100	556.3%	1.71	-49.8%

*The beams (14, 15 and 16) have uniformly distributed load, i.e. the values of load capacity are in kN/m, while other beams have concentrated load, i.e. the values of load capacity are in kN.

3.1 The effect of beam dimensions

Changing the dimensions of a beam section evidently affects load capacity on the one hand and endspan deflection on the other. Accordingly, the effect of the beam height and then its width is studied in the subsequent paragraphs.

3.1.1 The effect of beam height

Increasing the height of the beam (1000 mm, 1120 mm, 1365 mm and 1665 mm) leads to an increase in the area of the beam section, which increases the section compression zone that is located in the lower part of the beam section. It also increases the ability of the section to resist

torque that leads to an increase in the section strength. Increasing the beam height by 12%–66.5% also leads to an increase in the moment of inertia for the rectangular beam section, thus decreasing the endspan deflection.

- Negative moments increase by about 11.23%–76.33%, as shown in Figure 3.
- Torsional moments increase by about 11.17%–77%, as shown in Figure 4.
- Load capacity increased by about 11.1%–77.8, as shown in Figure 5.
- Deflection decreases by about 14.89%–38.72%, as shown in Figure 6.

Figure 7 shows how the failure occurred at the support zone in the beam 1365 mm high, as an example.

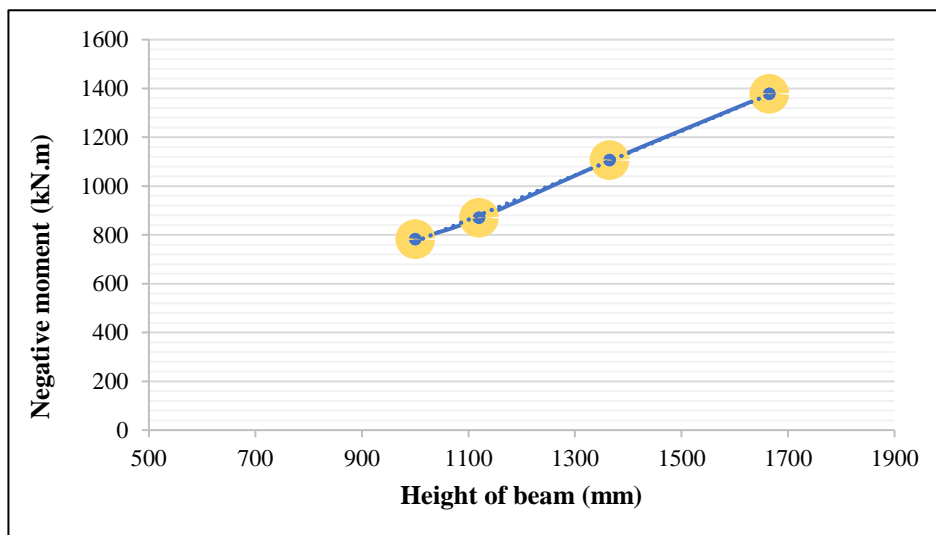

Figure 3. Effect of height variation on negative moment

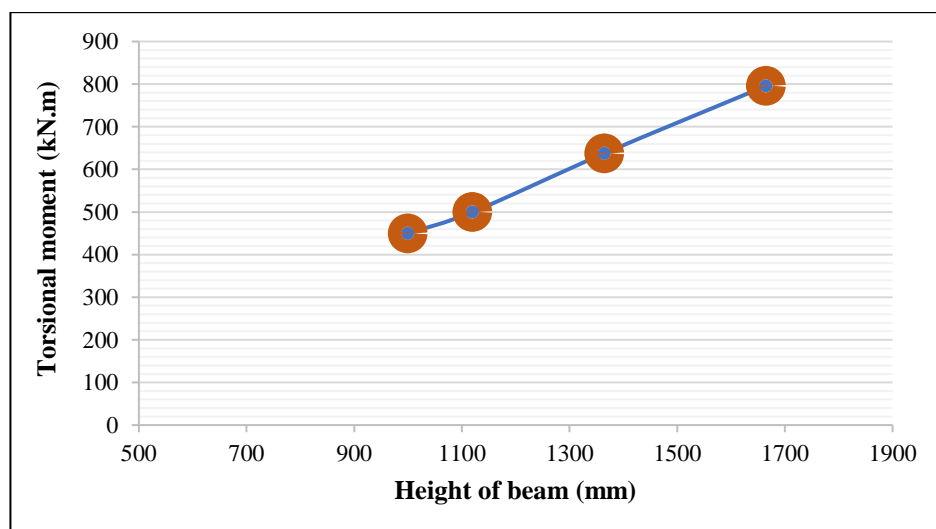

Figure 4. Effect of height variation on the moment of torsion

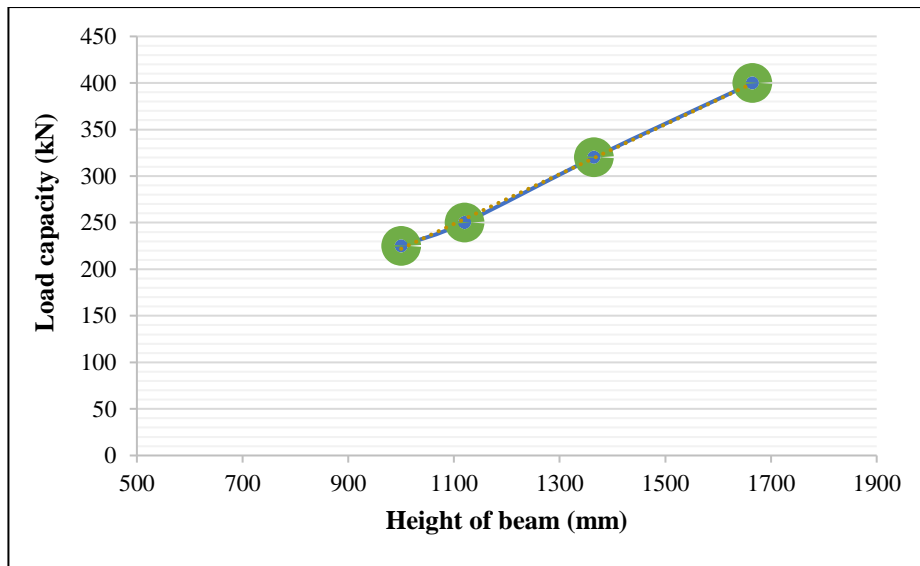

Figure 5. Effect of height variation on load capacity

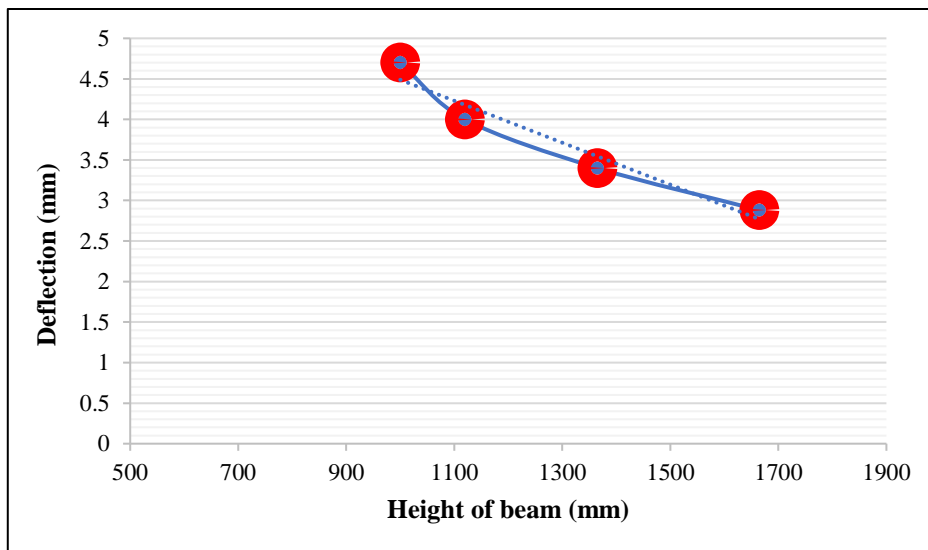

Figure 6. Effect of height variation on deflection

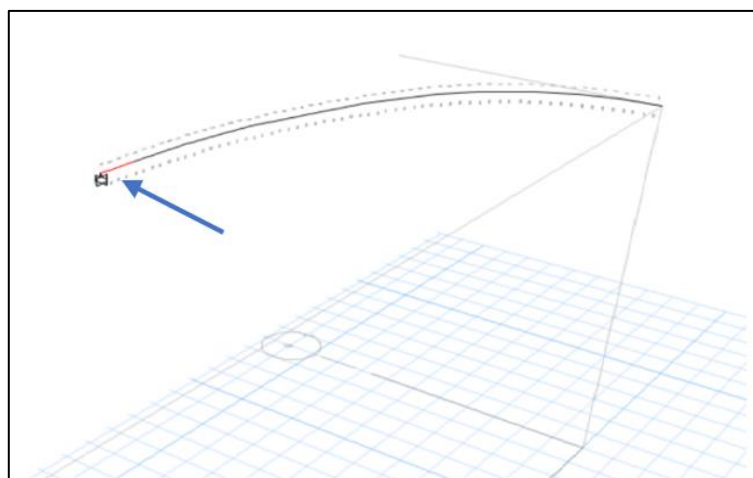

Figure 7. Location of failure of a beam with 2400 mm height

3.1.2 The effect of beam width

Increasing the width of the beam leads to an increase in the section's ability to resist more moments, whether they are flexural or torsional, as mentioned in the previous subsection. Therefore, when the width is increased by 14.3%–81%, the following results are obtained:

- Negative moments increase by about 26.13%–166.53%, as shown in Figure 8.

- Torsional moments increase by about 27%–172.54%, as shown in Figure 9.
- Load capacity increases by about 28%–180%, as shown in Figure 10.
- Deflection decreases by about 1.73%–2.31%, as shown in Figure 11.

Figure 12 shows how the failure occurs at the support zone in the beam that is 600 mm wide as an example.

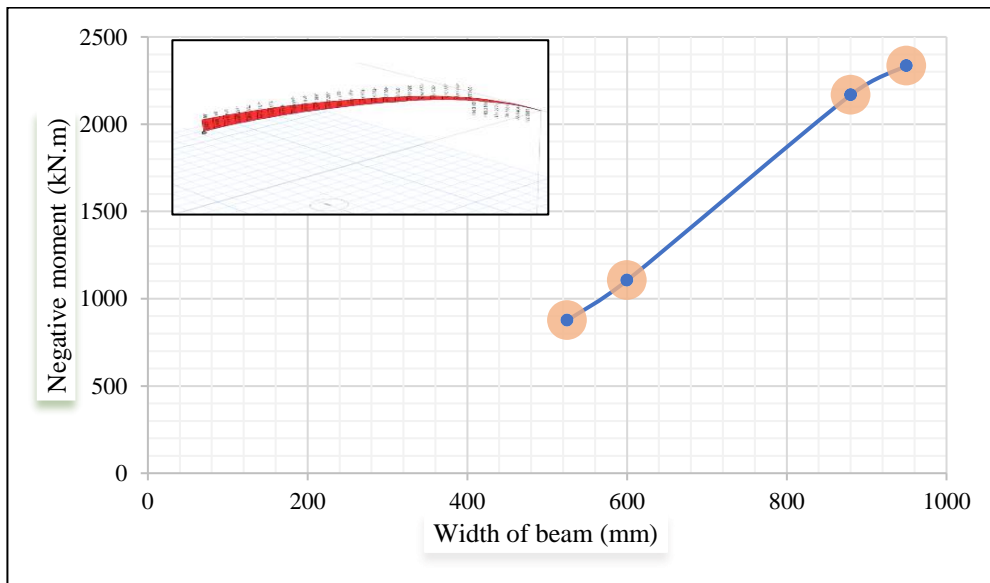

Figure 8. Effect of width variation on negative moments

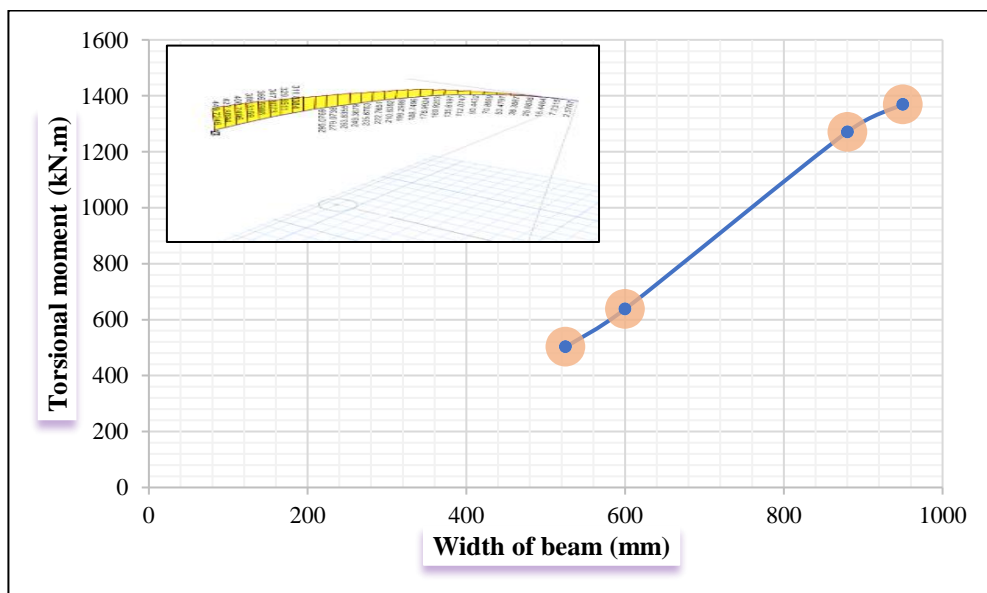

Figure 9. Effect of width variation on the torsional moments

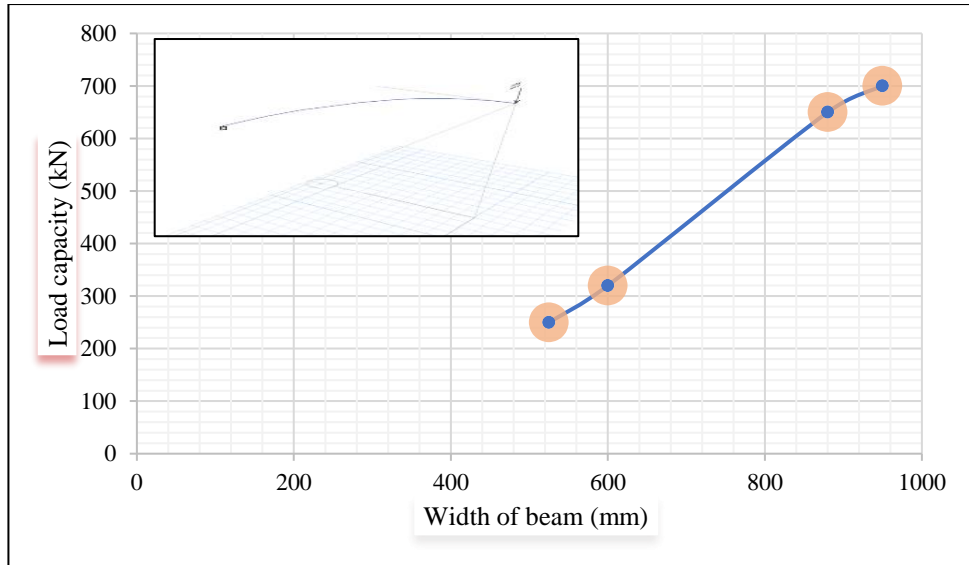

Figure 10. Effect of width variation on load capacity

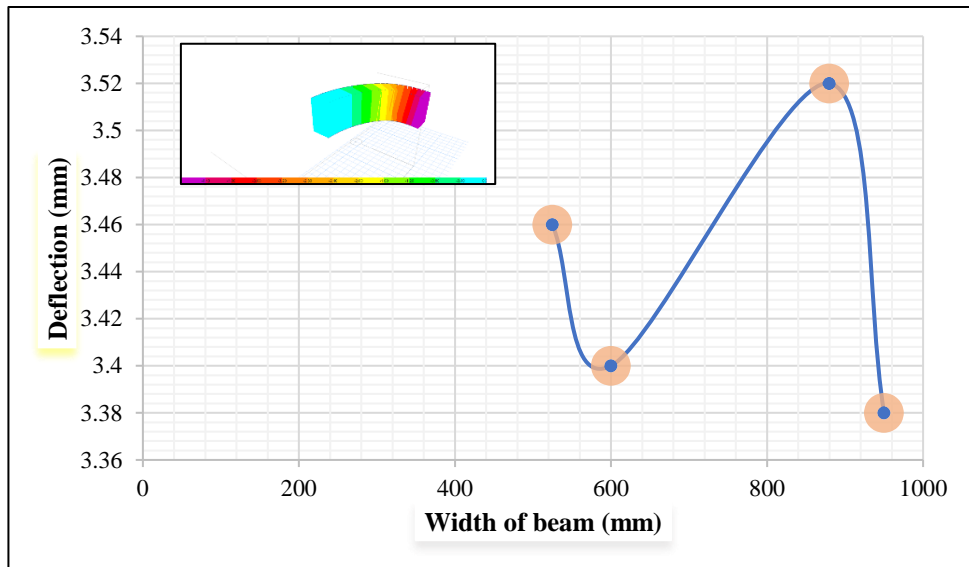

Figure 11. Effect of width variation on deflection

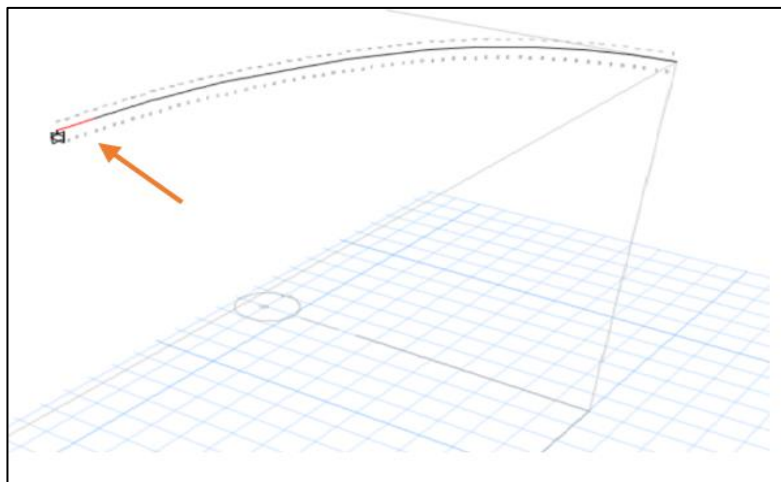

Figure 12. Location of failure in a 600 mm width beam

3.1.3 The effect of concrete compressive strength

One of the important parameters in the strength of reinforced concrete beam section is the compressive strength of concrete. As the value of the compressive strength increases, the ability of the section to resist moments increases, so the load capacity increases, and the deflection decreases. Accordingly, increasing concrete compressive strength by 7.54%–36.1%, leads to the following:

- Negative moments increase by about 8.22%–19.2%, as shown in Figure 13.
- Torsional moments increase by about 8.73%–20.4%, as shown in Figure 14.
- Load capacity increases by about 9.4%–22%, as shown in Figure 15.
- Deflection increases by about 4.71%–7.1%, as shown in Figure 16.

Figure 17 shows how the failure occur at the support zone in the beam with a concrete compressive strength of 30.5 MPa as an example.

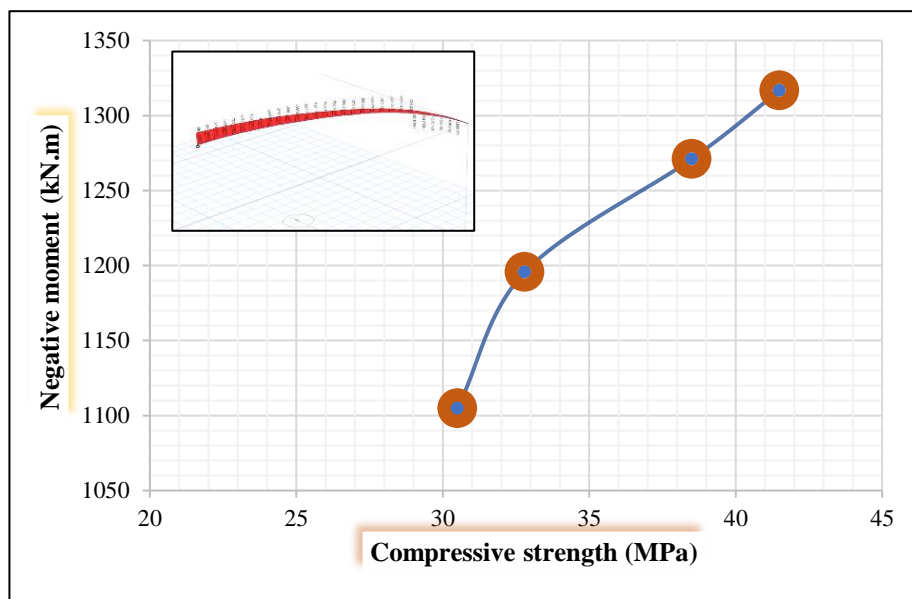

Figure 13. Effect of compressive strength variation on negative moments

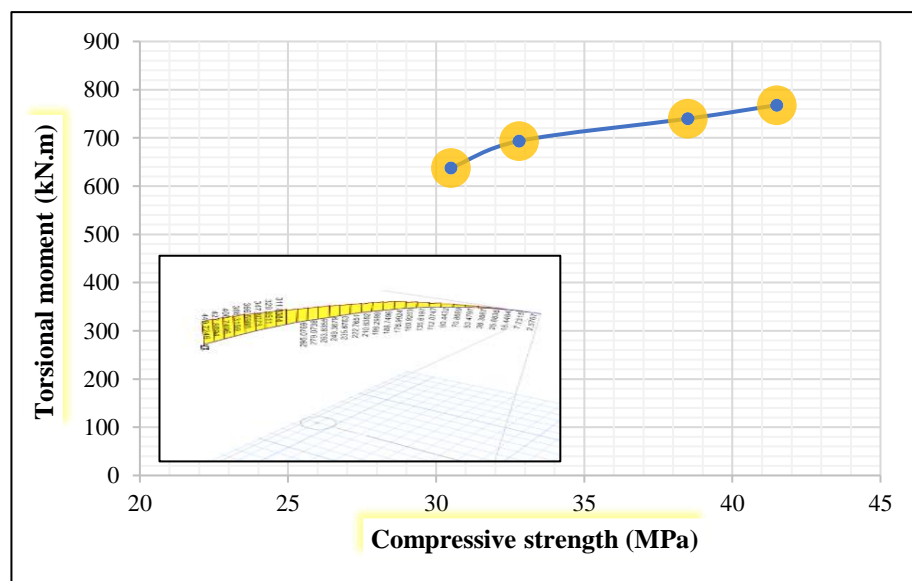

Figure 14. Effect of compressive strength variation on torsional moments

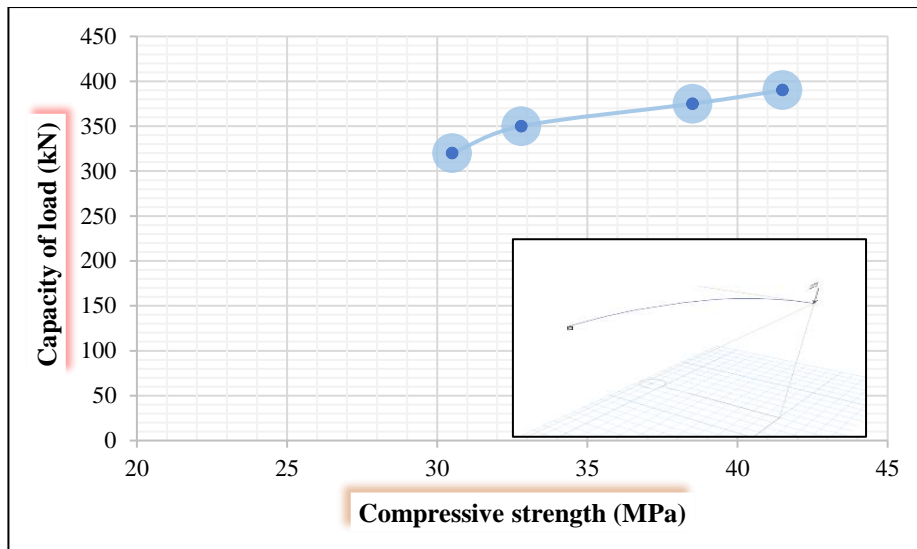

Figure 15. Effect of compressive strength variation on capacity of load

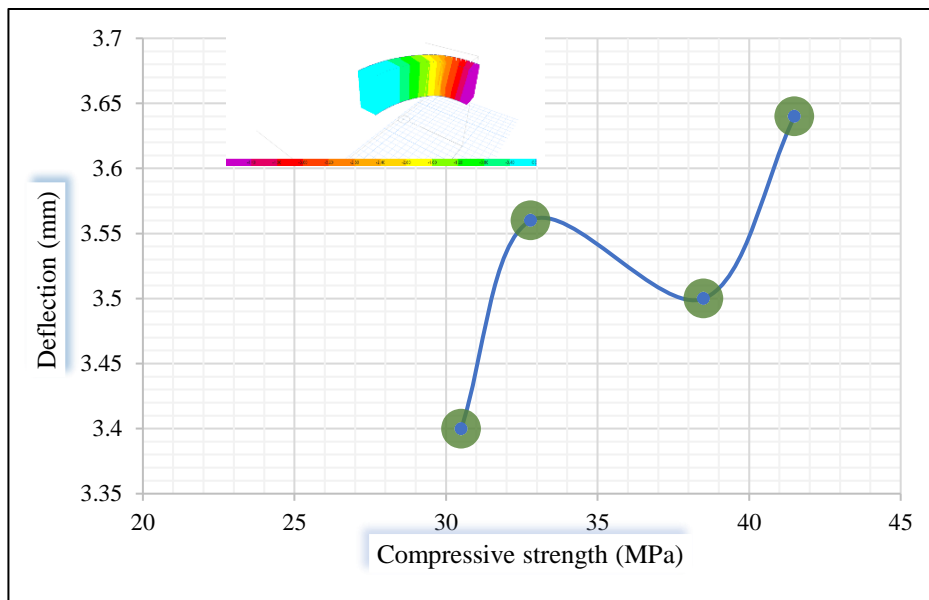

Figure 16. Effect of compressive strength variation on deflection

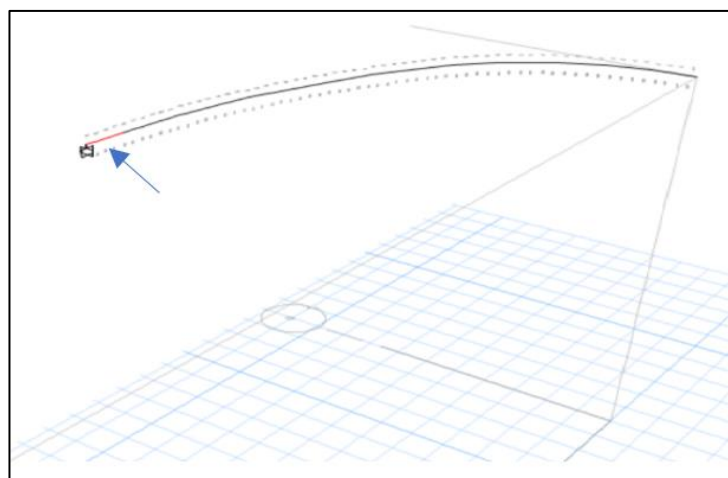

Figure 17. Location of failure of a beam with 30.5MPa compressive strength

3.2 The effect of the loading type

The concentrated load which is located at the end of the beam (free end) is converted into three types of partially uniformly distributed load, more specifically, one third of the span's length (33% L), two-thirds of the span's length (66% L) and the whole span's length (100% L) (see Figure 18). Converting a concentrated load to a distributed one, in general, leads to a decrease in the stress concentration, thus increasing the loading capacity and reducing the deflection. In addition, increasing the loading capacity leads to an increase in the negative moments because they are the moments of failure. As for the torsional moments, they decrease because the centre of the distributed load becomes closer to the support (decreasing the arm of torsion). In more detail, converting

the concentrated load into uniformly distributed one by 33%, 66% and 100% of span length leads to the following:

- Negative moments increase by about 5.23%–52.7%, as shown in Figure 19.
- Torsional moments decrease by about 1.1%–16%, as shown in Figure 20.
- An increase in the load capacity by about 306% and 181% takes place when loading 33% and 66% of the span's length, but it decreases by about 31% when loading 100% of the span's length, as shown in Figure 21.
- Decrease in deflection by about 1.76%–11.8%, as shown in Figure 22.

Figure 23 shows how the failure occurred at the support zone in the beam with 100% of span's length load as an example.

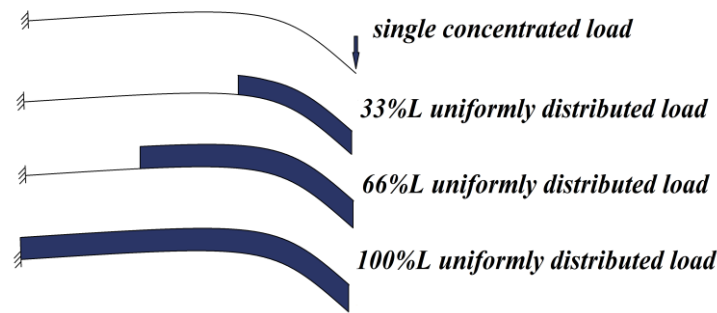

Figure 18. Distribution of the uniform load on the beams by the method of thirds

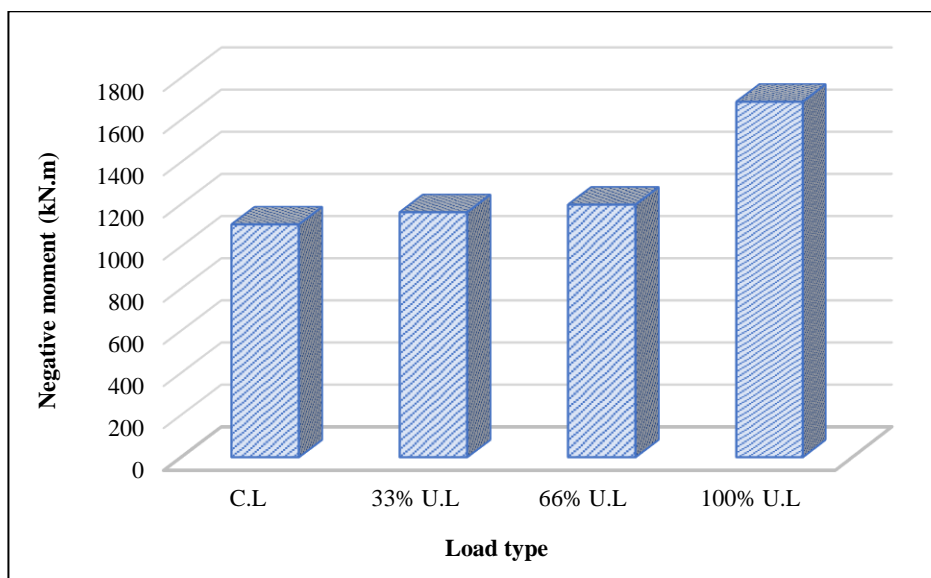

Figure 19. Influence of load type variation on negative moments

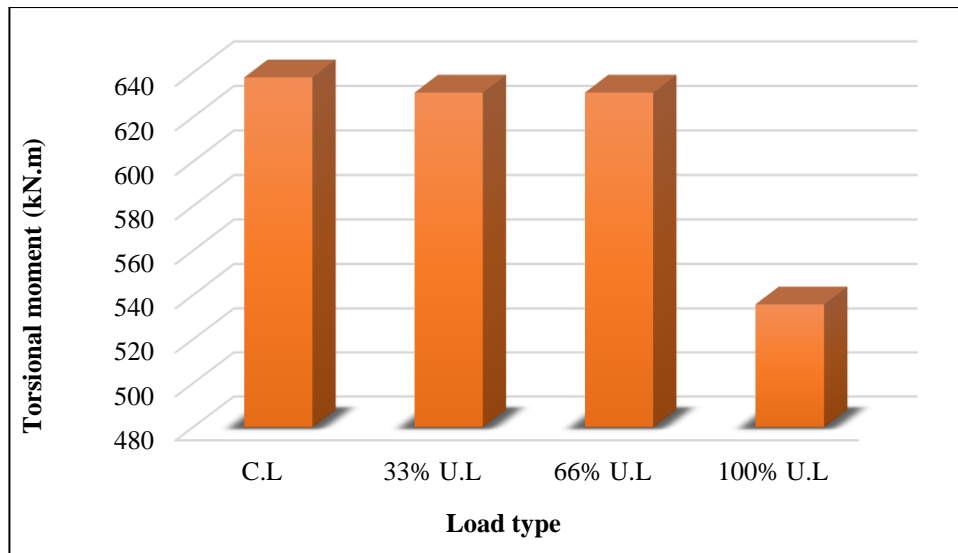

Figure 20. Influence of load type variation on torsional moments

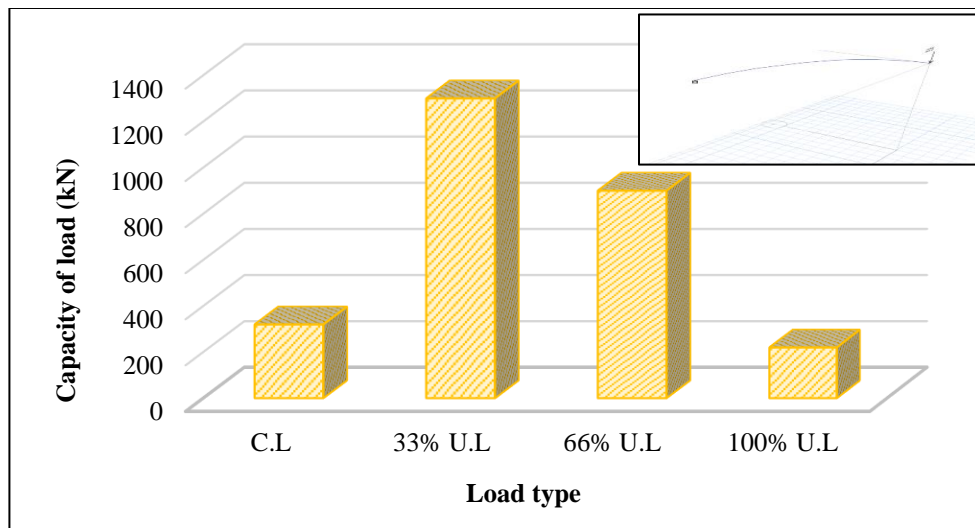

Figure 21. Influence of load type variation on capacity of load

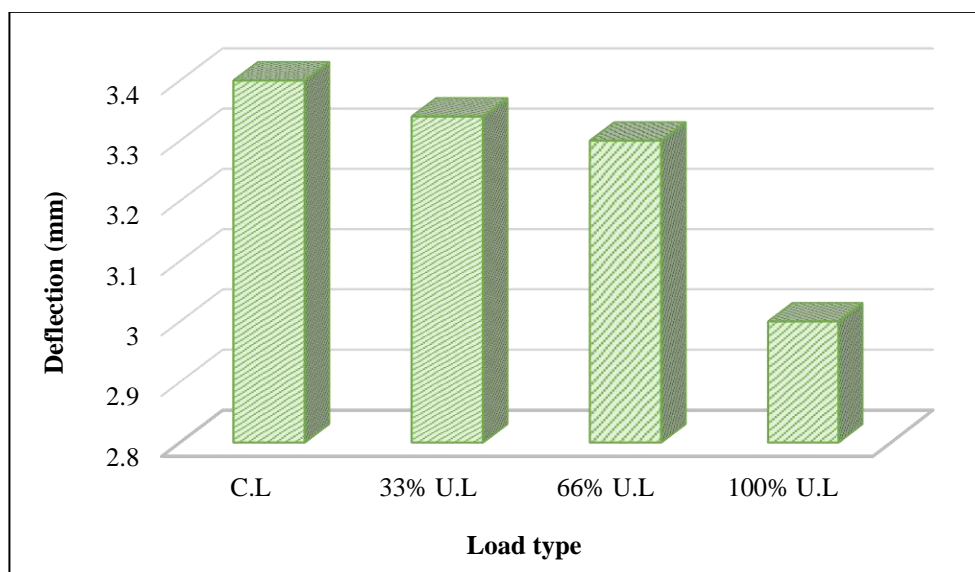

Figure 22. Influence of load type variation on deflection

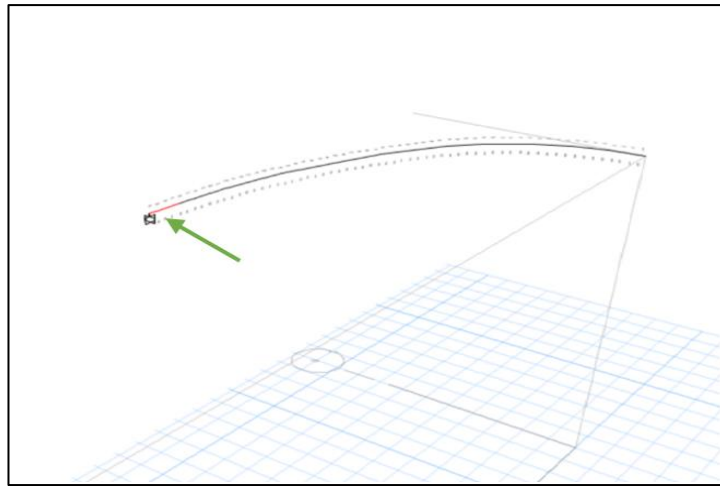

Figure 23. Location of failure of a beam with 100% uniform load of span

3.3 The effect of the loading position

When moving the concentrated load located at the free end of the beam (1 L), bringing it to the fixed end by a quarter of the span's length each time (i.e., 0.75 L, 0.5 L and 0.25 L), the results are directly affected. The load capacity increases with an increase in the deflection, and it is because of the increase in the negative moments (failure moments) due to the shortening of their arms. As for torsional moments, they decrease due to the shortness of their torsional arms and the elliptical shape characteristic. In more detail, moving the

contracted load from 1 L to 0.25 L leads to the following:

- Negative moments increase by about 56.9%–110%, as shown in Figure 24.
- Torsional moments decrease by about 8.64%–58.3%, as shown in Figure 25.
- Loading capacity increases by about 87.5%–556.25%, as shown in Figure 26.
- Deflection decreases by about 3.24%–49.8%, as shown in Figure 27.

Figure 28 shows the failure of the cantilever beam when the concentrated load is located at a distance of a quarter of the span's length from the fixed support as an example.

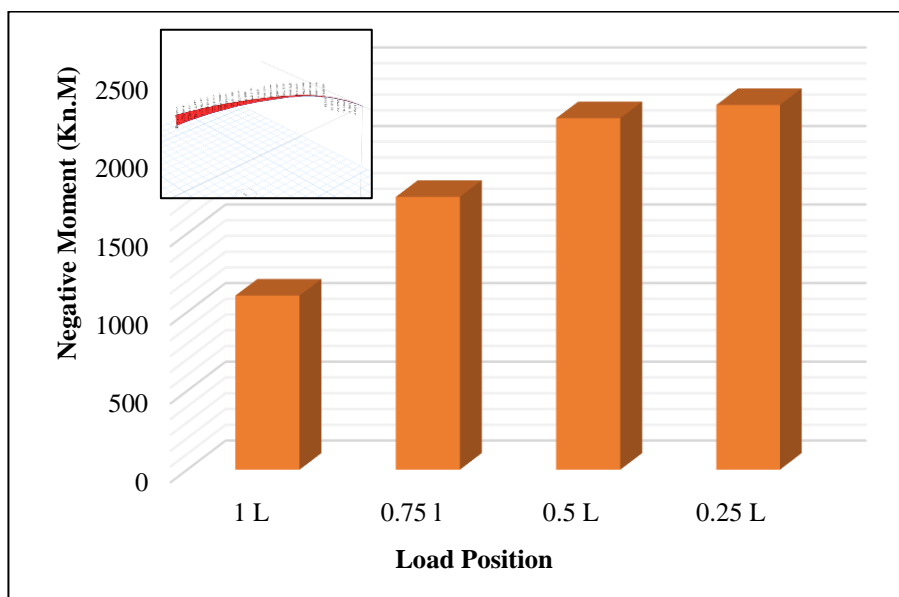

Figure 24. Influence of load position variation on negative moments

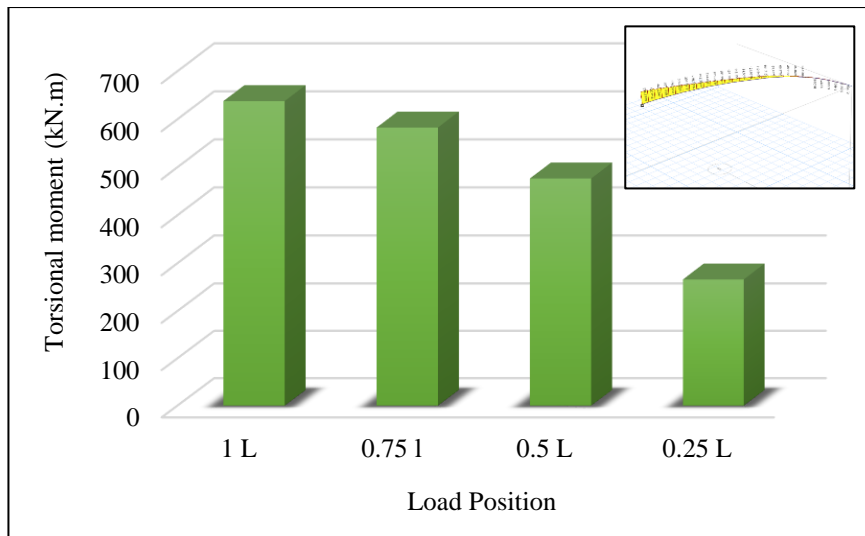

Figure 25. Influence of load position variation on torsional moments

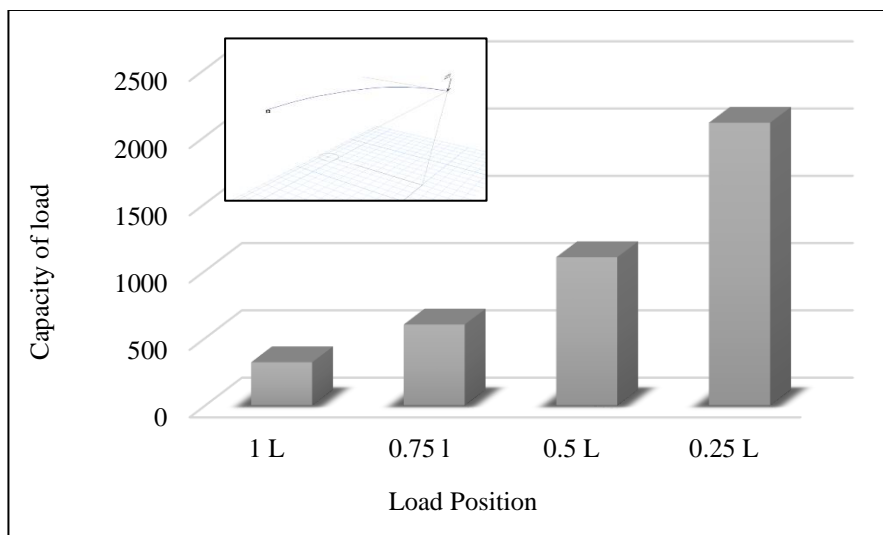

Figure 26. Influence of load position variation on capacity of load

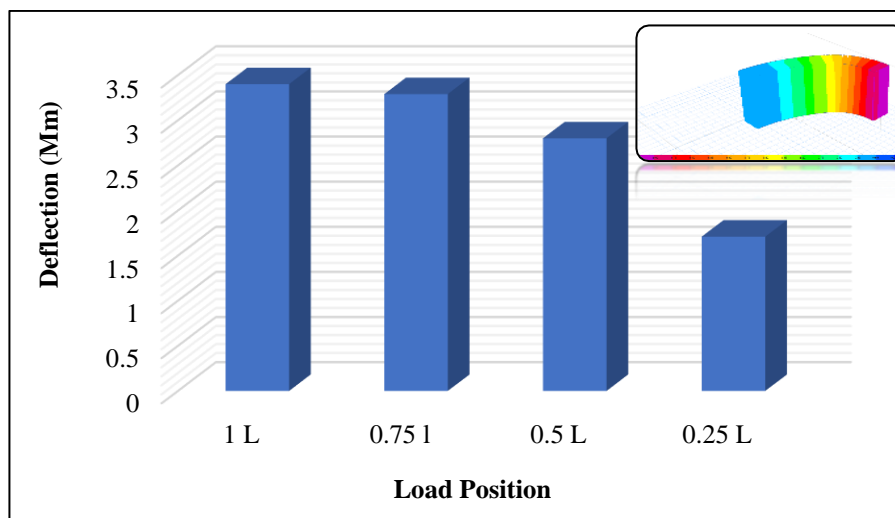

Figure 27. Influence of load position variation on deflection

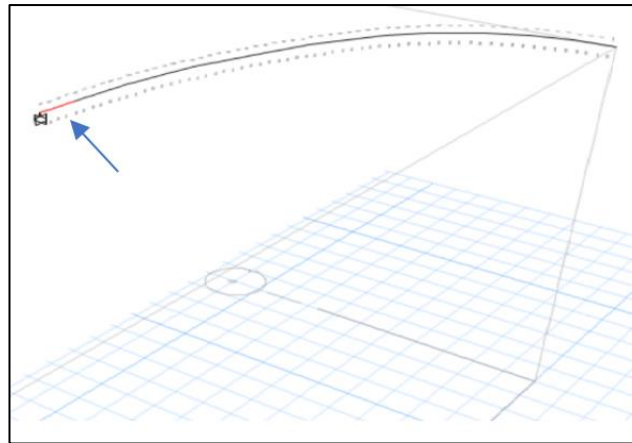

Figure 28. Location of failure of a beam with 0.25L of span

4. Conclusions

In this research, the ETABS 2019 software was used to carry out the well-known finite element method. Twenty reinforced concrete elliptical cantilever deep beams were analysed, and they were divided into five groups. Each group contained four specimens that dealt with one of the influential parameters affecting the behaviour of this type of beams. The effects of beam section height, beam section width, compressive strength of concrete used in casting, load type and its location were studied. Many results were reached, and the most prominent of which can be summarized are as follows:

- The increase in the height of the beam section increases the concrete area above the neutral axis, so the section's ability to resist negative moments increases. The increase in the cross-section area also increases its ability to resist the torsional moments that are concentrated on its sides. Therefore, the loading capacity increases accompanied by a decrease in deflection due to the increase in the moment of inertia. Specifically, when the height increases by 12%–66.5%, negative moments, torsional moments and load capacity increased by about 11.23–76.33%, 11.17–77% and 11.1–77.8%, respectively. Nonetheless, with increasing height, deflection decreases by 14.9%–38.7%.
- As the width of the beam section increases, the concrete area above the neutral axis enhances the ability of the beam section to resist negative moments. In addition, the enlargement in concrete size of the cross section enhances the section's ability to resist the torsional moments that are focused on its sides. Based on the above, the load capacity increases, but the deflection decreases due to the increase in the moment of inertia. In more detail, increasing the width by 14.3%–81%, leads to an increase in the negative moments, torsional moments and load capacity with a decrease in deflection by about 26.13%–166.53%, 27%–172.54%, 28%–180% and 1.73%–2.31%, respectively.
- Increasing the compressive strength of concrete leads to an increase in the ability of the beam section to resist negative and torsional moments. As a logical result, the load capacity increases, and deflection decreases. Specifically, when the compressive strength of concrete is increased by 7.54%–36%, the negative and torsional moments, load capacity and deflection increase by about 8.22%–19.2%, 8.73%–20.4%, 9.4%–22% and 4.71%–7.1, respectively.
- In general, changing a concentrated load to a partially uniformly distributed one causes the stress concentration to drop,

thus improving the loading capacity and decreasing deflection. Additionally, raising the loading capacity causes the negative moments to rise because they are the moments of failure. The torsional moments are reduced when the distributed load's centre moves closer to the fixed support (shortening the arm of torsion). In more detail, converting the concentrated load into uniformly distributed one by 33%, 66% and 100% of span length leads to increasing the negative moments by about 5.23%–52.7%, decreasing the torsional moments by about 1.1%–16%, increasing the load capacity by about 306% and 181% when loading 33% and 66% of the span's length. Although load capacity decreases by about 31% when loading 100% of the span's length, deflection decreases by about 1.76% – 11.8%.

- Moving the concentrated load from the free end of the beam towards the fixed end, by a quarter of the span's length each time; $0.75 L$, $0.5 L$ and $0.25 L$ demonstrate clear effects. The load capacity increases with an increase in the deflection because the increase in the negative moments (failure moments) is due to the shortening of their arms. Torsional moments decrease due to the shortness of their torsional arms and the elliptical shape characteristic. In more detail, negative moments increase by about 56.9%–110%, torsional moments decrease by about 8.64%–58.3%, loading capacity increases by about 87.5%–556.25% and, finally, deflection decreases by 3.24%–49.8%.

References

- [1] Abdul-Razzaq, K.S., Jalil, A.M. and Dawood, A.A., 2020, March. Ring deep beam—A parametric study. In AIP Conference Proceedings, Vol. 2213, Number 1, p. 020128. AIP Publishing LLC.
- [2] ACI Committee and American Concrete Institute, 2014. Building Code Requirements for Structural Concrete (ACI 318-14) and Commentary.
- [3] Abdul-Razzaq, K. S., and Jebur, S. F., 2017. Suggesting Alternatives for Reinforced Concrete Deep Beams by Reinforcing Struts and Ties. ASCMCES-17, MATEC Web of Conferences, Vol. 120, 01004, pp.1-13.
- [4] Abdul-Razzaq, K. S., and Jebur, S. F., 2018. Experimental Verification of Strut and Tie Method for Reinforced Concrete Deep Beams under Various Types of Loadings. Journal of Engineering and Sustainable Development, 21(6), pp.39-55.
- [5] Abdul-Razzaq, K. S., Jebur, S. F., and Mohammed, A. H., 2018. Concrete and Steel Strengths Effect on Deep Beams with Reinforced Struts. International Journal of Applied Engineering Research ISSN, Vol. 13, Number1, pp. 66-73.
- [6] Abdul-Razzaq, K. S., Jebur, S. F., and Mohammed, A. H., 2018. Strut and Tie Modeling for RC Deep Beams under non-Central Loadings. Civil Engineering Journal, Vol. 4, Number 5, pp. 937-948.
- [7] Abdul-Razzaq, K. S., and Jalil, A. M., 2017. Behavior of Reinforced Concrete Continuous Deep Beams-Literature Review. The Second Conference of Post Graduate Researches (CPGR'2017), College of Engineering, Al-Nahrain University, Baghdad, Iraq-4th.
- [8] Jalil, A. M., Hamood, M. J., Abdul-Razzaq, K. S., and Mohammed, A. H., 2018. Applying Different Decentralized Loadings on RC Continuous Deep Beams Using STM. International Journal of Civil Engineering and Technology, Vol. 9, Number11, pp. 2752–2769.
- [9] Jalil, A. M., Hamood, M. J., Abdul-Razzaq, K. S., and Mohammed, A. H., 2018. Applying Different Decentralized Loadings on RC Continuous Deep Beams Using STM. International Journal of Civil Engineering and Technology, Vol. 9, Number11, pp. 2752–2769.
- [10] Mohammedali, T. K., Jalil, A. M., Abdul-Razzaq, K. S., and Mohammed, A. H., 2019. STM Experimental Verification for Reinforced Concrete Continuous Deep Beams. International Journal of Civil Engineering and Technology (IJCIET), 10(2), pp.2227–2239.
- [11] Abdul-Razzaq, K.S., Jalil, A.M. and Dawood, A.A., 2020, March. Reinforced concrete continuous deep beams under the effect of different parameters. In AIP Conference Proceedings, Vol. 2213, Number 1, pp. 020127. AIP Publishing LLC.

- [12] Peter Marti, 1985. Basic Tools of Reinforced Concrete Beam Design. ACI Journal Proceedings, Vol. 82, Number 1.
- [13] Comité Euro-International du Béton CEB-FIP. 1993. CEB-FIP model code 1990 for concrete structures. CEB-FIP 90, Bulletin d'Information Number 213-214, Lausanne, Switzerland.
- [14] Hu, O. E., K. H. Tan, and X. H. Liu. 2007. Behaviour and strut-and-tie predictions of high-strength concrete deep beams with trapezoidal web openings. Magazine of Concrete Research Vol. 59, Number 7, pp. 529-541.
- [15] Abdul-Razzaq, K. S., Abed, A. H., and Ali, H. I., 2016. Parameters Affecting Load Capacity of Reinforced Self-Compacted Concrete Deep Beams. International Journal of Engineering, 5(05), pp.225-233.
- [16] Yang, K.H. and Ashour, A.F., 2011. Aggregate interlock in lightweight concrete continuous deep beams. Engineering Structures, Vol. 33, Number1, pp.136-145.
- [17] Beshara, F.B.A., Shaaban, I.G. and Mustafa, T.S., 2012. Behaviour and Analysis of Reinforced Concrete Continuous Deep Beams. In 12th Arab Structural Engineering Conference, Tripoli, Libya.
- [18] Al-Tameemi, H.A., Ali, A.P.D.A.Y. and Attiyah, A.N., 2010. Three-dimensional nonlinear finite element analysis of reinforced concrete horizontally curved deep beams, Journal of Babylon University/Engineering Sciences, Vol.18, Number1.